



# Vitrina, FRÍO



Grupo Incorporado  
pag 12 - 37



Grupo Remoto  
pag 38 - 76



Vitrinas Ingredientes  
pag 77 - 79

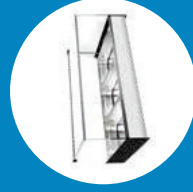

Vitrinas Comidas  
para llevar  
pag 80-81





**Embraco**

- Compresor Hermético ALTA TEMPERATURA
- Monofásico 220V / 240V 50hz
- EMT6144U Potencia Frigorífica 343w a -10° C.V 1/5
- EMT6165U Potencia Frigorífica 478w a -10° C.V 1/4
- Temperatura de trabajo +1°C / +5°C
- Gas refrigerante R-290 PROPANO



- Control de temperatura mediante termostato electrónico digital con lectura constante y posibilidad de desescarche.



- Perfil sanitario para una correcta limpieza de las guías correderas.



- Iluminación LED impermeable LUZ FRÍA protección IP 65 DC 12V 6000 K



**LU-VE**  
GROUP

- Condensador LU-VE

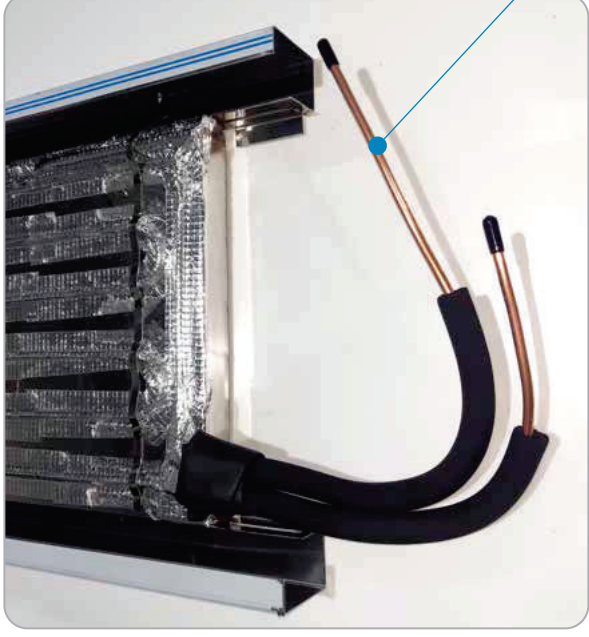

1/4 08

- Evaporador Interior en cobre 1/4 espesor 0.8 mm
- Sujeción a la base con cinta adhesiva de maya y tira de chapa Inox soldada con puntos



- Bandeja Interior de vitrina en Chapa de Acero Inoxidable AISI 304 de 1 mm de grosor



- Inyectado interior de vitrina en poliuretano libre de CFS de 5 cm

**i** Elija sin coste ninguno el lado del motor según camarero, a izquierda o derecha

GRUPO INCORPORADO  
VITRINA REFRIGERADA



Pag 14  
**20R-F6**

Vitrino Curvo Radio 20



Pag 15  
**20R-F150**

Vitrino Curvo Radio 20



Pag 16  
**SHS-200i**

Vitrino Shushi



Pag 19  
**SHS-6iE**

Vitrino Shushi con estante



Pag 20  
**FR-6i**

Vitrino Curvo



Pag 21  
**FR-6iE**

Vitrino Curvo con Estante



Pag 22  
**R-6i**

Vitrino Recto



Pag 23  
**R-4iE**

Vitrino Recto con Estante





Pag 24

**ABF-6C**

Vitrina Curvo con Estante Abierto



Pag 25

**ABF-6R**

Vitrina Recto con Estante abierto



Pag 26

**A2BF**

Vitrina Recto con 2 Estantes



Pag 28

**VN-150**

Vitrina Curvo con Decoración en Vinilo

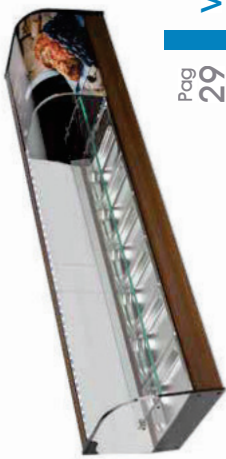

Pag 29

**VN-6E**

Vitrina Curvo con Decoración en Vinilo con Estante



Pag 30

**RCT-150**

Vitrina Recto hasta Nivel de Barra

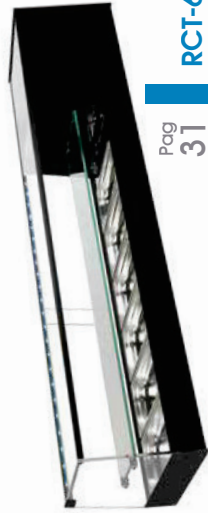

Pag 31

**RCT-6E**

Vitrina Recto con Estante hasta Nivel de Barra



Pag 32

**RCT-150A**

Vitrina Recto con Estante abierto hasta Nivel de Barra



Pag 33

**MB-6**

Vitrina de Bandejas Melanina 1/3 h65



Pag 34

**F-BLACK120**

Vitrina Curvo hasta Nivel de Barra



Pag 35

**CTB-6**

Vitrina Contrabarra



Pag 36

**DB-Fi6**

Vitrina Doble Refrigeradora





CRISTAL RECTO



Temperatura de Trabajo



+1°/+5°

Accesorios disponibles



Pag 82

Especificaciones técnicas



Pag 10

Modelo  
**20R**

- Iluminación LED.
- Puertas correderas en metacrilato.
- Cristal Curvado Templado Radio 20.

CRISTAL CURVO  
RADIO 20°

20R-F6 PLATA

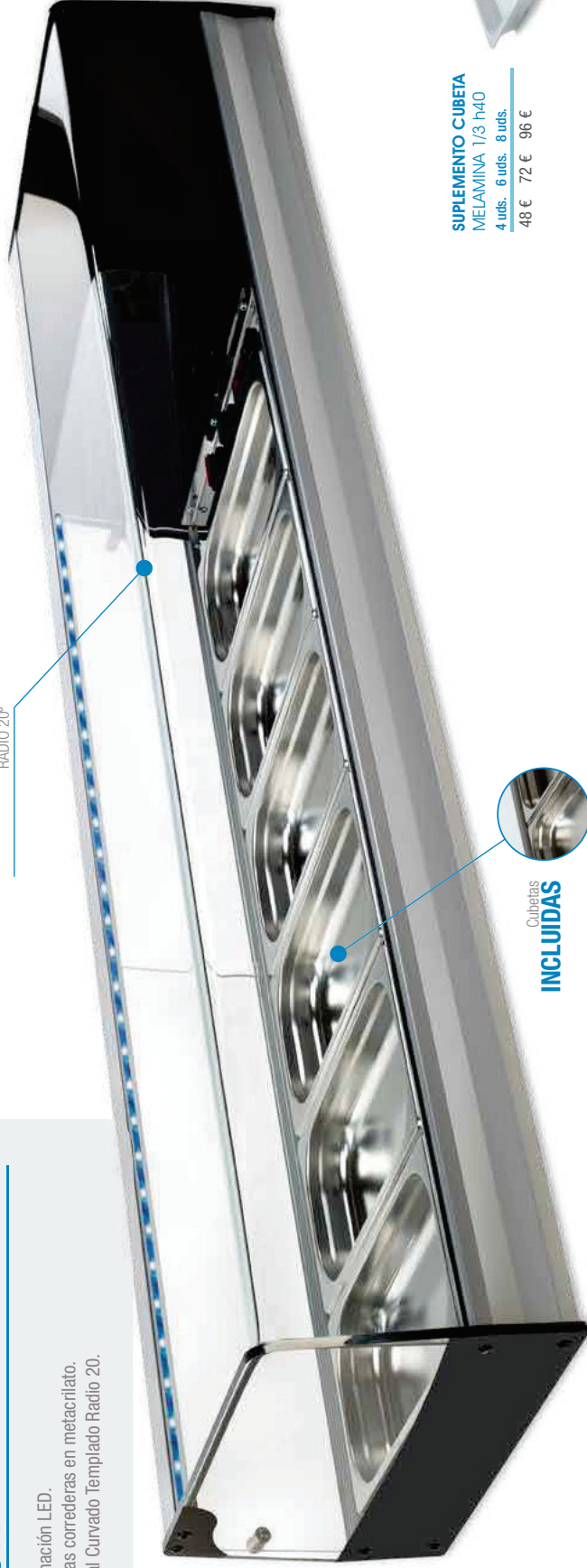

Cubetas  
**INCLUIDAS**

**SUPLEMENTO CUBETA**  
MELAMINA 1/3 h40  
4 uds. 6 uds. 8 uds.  
48 € 72 € 96 €



CRISTAL CURVADO RADIO 20°

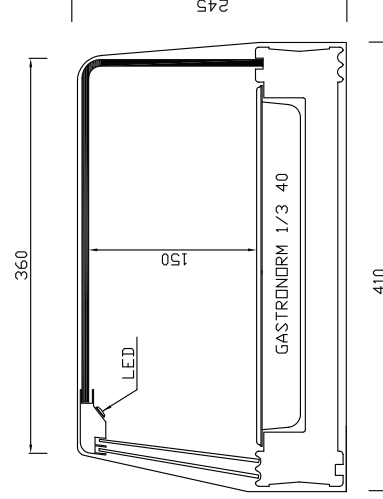

Modelo	Largo	Fondo	Alto	Cubetas (Incluidas)	Plata/Nogal/Blanco/Negro
20R-F4	1216	410	245	4	1.360 €
20R-F6	1566	410	245	6	1.440 €
20R-F8	1926	410	245	8	1.630 €

GRUPO INCORPORADO  
VITRINA REFRIGERADA

Placa fría

CRISTAL RECTO

Temperatura de Trabajo

+1°/+5°

Accesorios disponibles

Pag 82

Especificaciones técnicas

Pag 10



PLATA



NOGAL



BLANCO



NEGRO

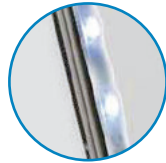

Iluminación  
**LED**

CRISTAL CURVO  
RADIO 20°

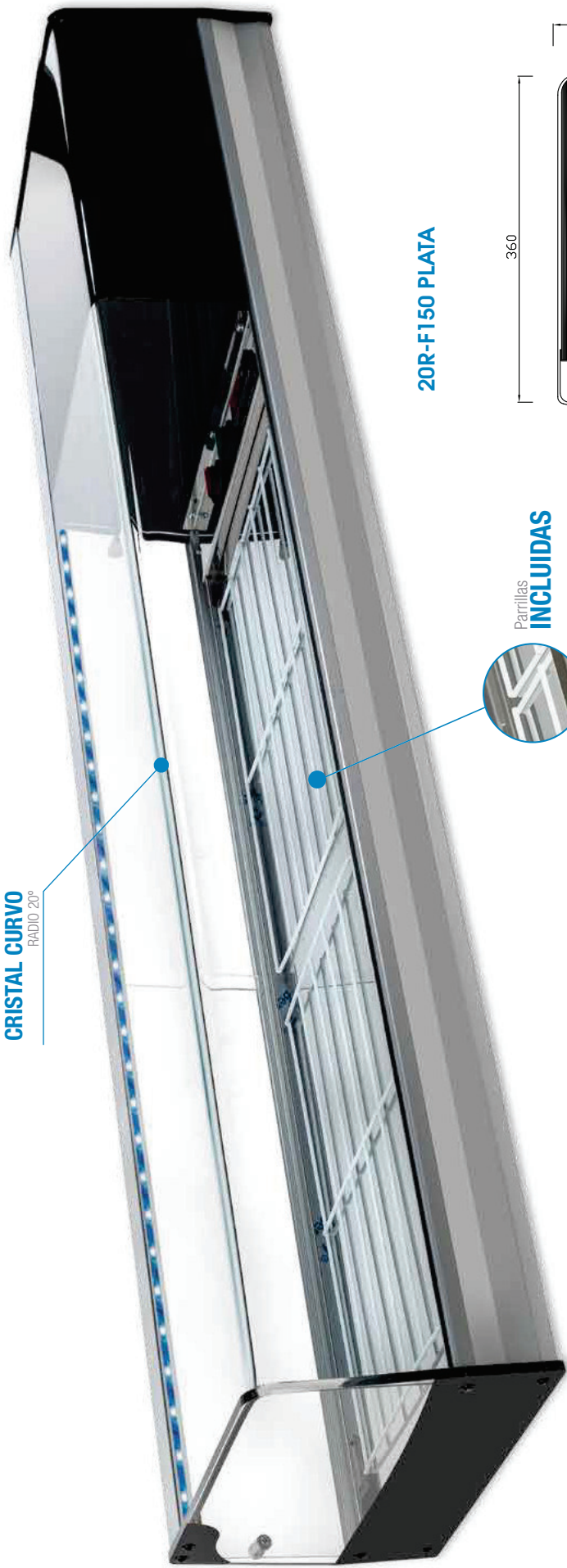

20R-FI150 PLATA



Parrillas  
**INCLUIDAS**

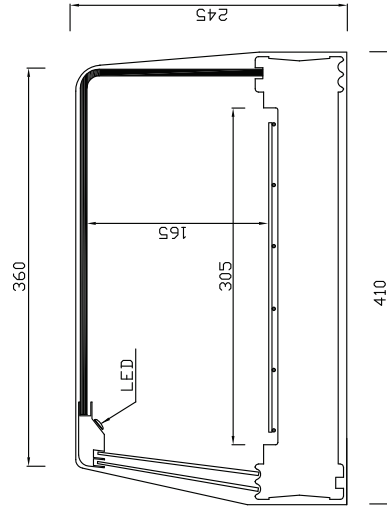

Modelo	Largo	Fondo	Alto	Parrillas	Plata/Nogal/Blanco/Negro
20R-FI20	1216	410	245	1.5	1.340 €
20R-FI50	1566	410	245	2	1.420 €
20R-F200	1926	410	245	3	1.610 €



Modelo  
**SHS**

- FRÍO ESTÁTICO EN PLACA FRÍA Y EVAPORADOR SUPERIOR.
- Bandeja para desague de Evaporador Superior.
- Manguera de Desague en la zona de camarero.
- Decoración de cristal en NEGRO.
- Cristal Curvo Templado Radio 20.
- Iluminación LED.
- Puertas correderas de metacrilato.
- Perfilera en color PLATA / NOGAL / BLANCO / NEGRO

**SUPLEMENTO CUBETA**

MELAMINA 1/3 h40

4 uds. 6 uds. 8 uds.

48 € 72 € 96 €



CRISTAL CURVADO RADIO 20°

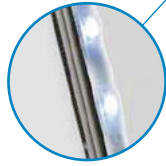

Iluminación  
**LED**

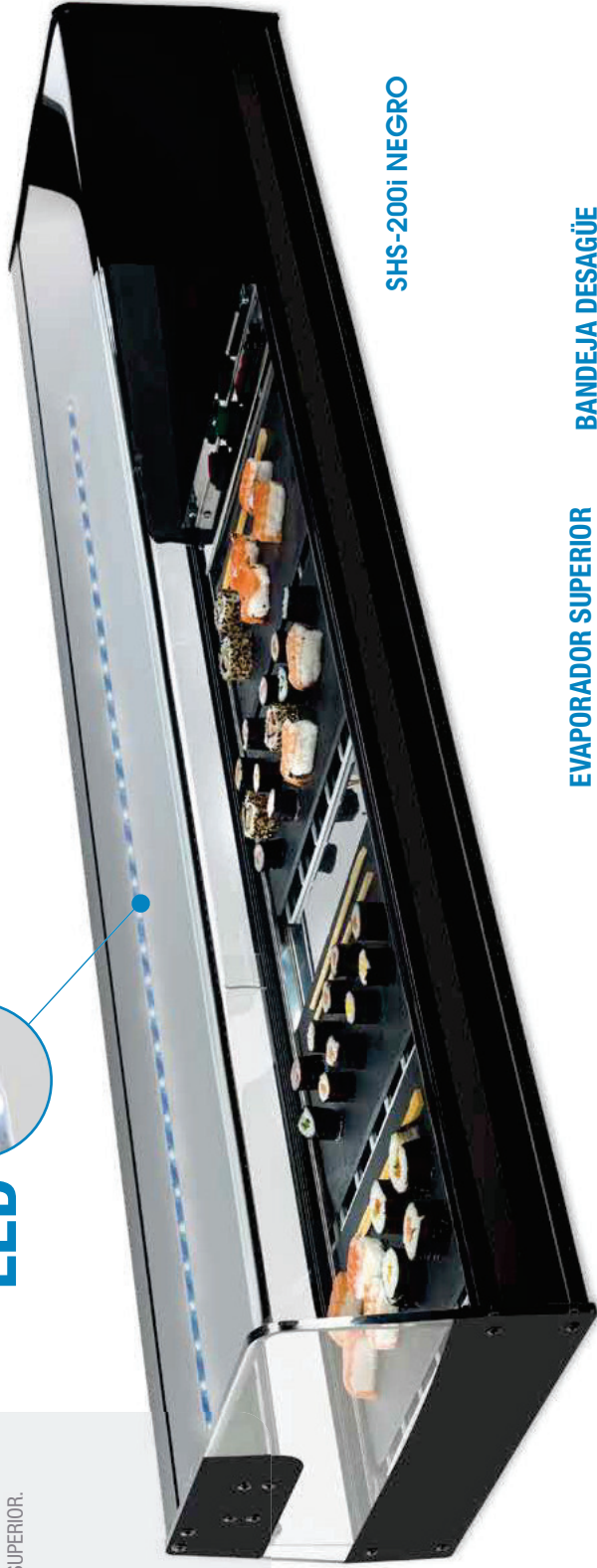

SHS-200i NEGRO

Modelo Largo Fondo Alto Cubetas Parrillas Plata/Nogal/Blanco/Negro

SHS-4i	1216	410	245	4	1.660 €
SHS-6i	1566	410	245	6	1.745 €
SHS-8i	1926	410	245	8	1.935 €

Modelo Largo Fondo Alto Parrillas Plata/Nogal/Blanco/Negro

SHS-120i	1216	410	245	1,5	1.640 €
SHS-150i	1566	410	245	2	1.725 €
SHS-200i	1926	410	245	3	1.915 €

EVAPORADOR SUPERIOR

BANDEJA DESAGÜE

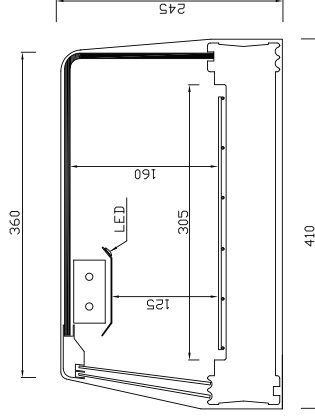





Temperatura de Trabajo



+1°/+5°



Accesorios disponibles



Pag 82



Especificaciones técnicas



Pag 10



Especificaciones técnicas

## Modelo SU

- FRÍO ESTÁTICO EN PLACA FRÍA Y EVAPORADOR SUPERIOR
- Bandeja para desagüe de Evaporador.
- Manguera de desagüe en la zona del camarero.
- Perfilera y decoración de cristal en NEGRO.
- Cristal Recto.
- Iluminación LED.
- Puertas correderas en metacrilato.
- Perfilera en color PLATA / NOGAL / BLANCO / NEGRO

NOVEDAD

### EVAPORADOR SUPERIOR

### SU-6 NEGRO



**SUPLEMENTO CUBETA MELAMINA 1/3 h40**  
4 uds. 6 uds. 8 uds.  
48 € 72 € 96 €

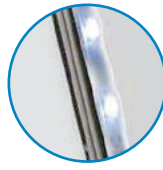
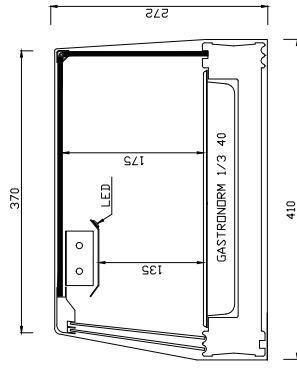

Iluminación LED

### SU-150 NEGRO

### PERFIL UNIÓN CRISTAL



PLATA



NOGAL



BLANCO



NEGRO

Modelo	Largo	Fondo	Alto	Cubetas	Plata/Nogal/Blanco/Negro
SU-4	1216	410	272	4	1.390 €
SU-6	1566	410	272	6	1.420 €
SU-8	1926	410	272	8	1.550 €

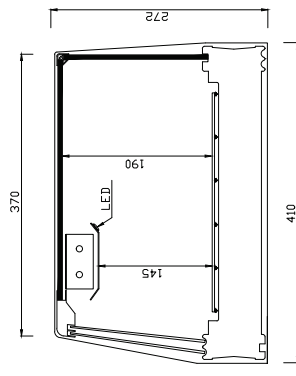

Modelo	Largo	Fondo	Alto	Parrillas	Plata/Nogal/Blanco/Negro
SU-120	1216	410	272	1,5	1.370 €
SU-150	1566	410	272	2	1.400 €
SU-200	1926	410	272	3	1.530 €

GRUPO INCORPORADO

# VITRINA REFRIGERADA SUSHI

Frío en Placa Fría y Evaporador Superior



PLATA



NOGAL



BLANCO



NEGRO

Modelo  
**SUC**

NOVEDAD

## EVAPORADOR SUPERIOR

## SUC-6 NEGRO

- FRÍO ESTÁTICO EN PLACA FRÍA Y EVAPORADOR SUPERIOR.
- Bandeja para desague de Evaporador. Superior.
- Manguera de desague en la zona del camarero.
- Decoración de cristal en NEGRO.
- Cristal Curvo Templado.
- Iluminación LED.
- Puertas correderas de metacrilato.
- Perfilera en color PLATA / NOGAL / BLANCO / NEGRO

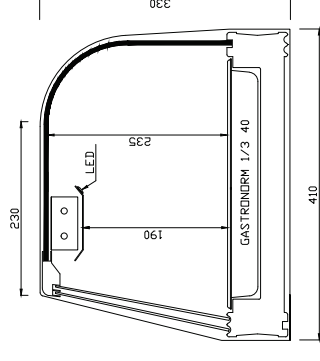
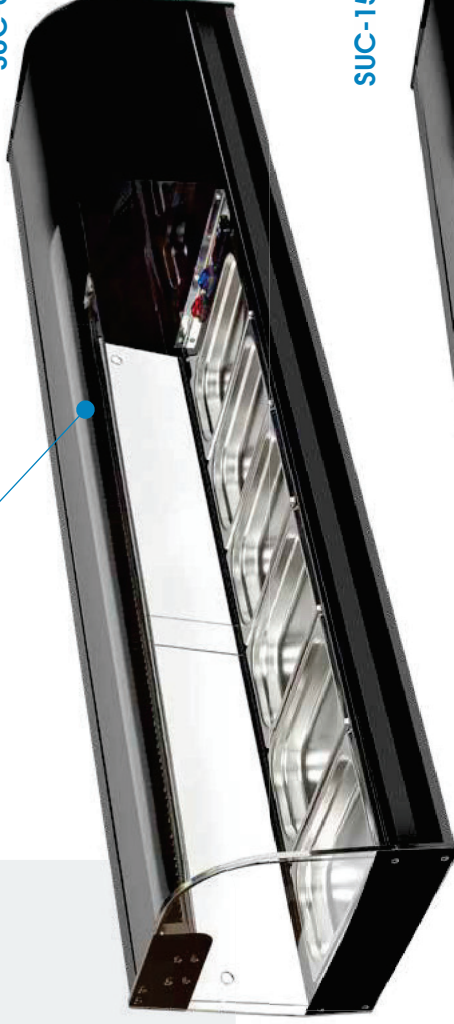

Fabricación Especial  
**A MEDIDA**

Pídanos Presupuesto

## SUC-150 NEGRO

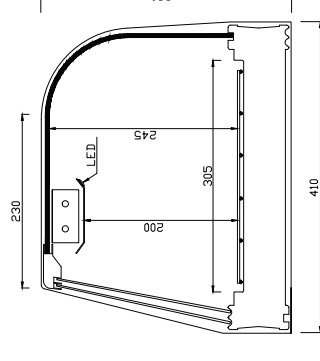

### SUPLEMENTO CUBETA

MELAMINA 1/3 1x40

4 uds. 6 uds. 8 uds.

48 € 72 € 96 €



Modelo	Largo	Fondo	Alto	Cubetas (incluidas)	Plata/Nogal/Blanco/Negro	Parrillas (incluidas)	Plata/Nogal/Blanco/Negro
SUC-4	1216	410	330	4	1.420 €	1.5	1.400 €
SUC-6	1566	410	330	6	1.450 €	2	1.430 €
SUC-8	1926	410	330	8	1.580 €	3	1.560 €
SUC-120	1216	410	330			1.5	
SUC-150	1566	410	330			2	
SUC-200	1926	410	330			3	

## Modelo SHS-E

- FRÍO ESTÁTICO EN PLACA FRÍA Y EVAPORADOR SUPERIOR
- Bandeja para desagüe de Evaporador.
- Manguera de desagüe en la zona del camarero.
- Decoración de cristal en NEGRO.
- Cristal Recto.
- Iluminación LED.
- Estante intermedio.
- Puertas correderas en metacrilato.
- Perfilera en color PLATA / NOGAL / BLANCO / NEGRO



Iluminación LED

## EVAPORADOR SUPERIOR



## SHS-6iE NEGRO

SUPLEMENTO CUBETA  
MELAMINA 1/3 h40  
4 uds. 6 uds. 8 uds.  
48 € 72 € 96 €

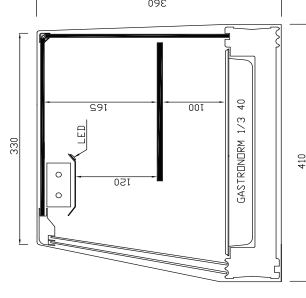

Modelo	Largo	Fondo	Alto	Cubetas	Plata/Nogal/Blanco/Negro
SHS-4iE	1216	410	360	4	1.740 €
SHS-6iE	1566	410	360	6	1.780 €
SHS-8iE	1926	410	360	8	1.970 €

## SHS-150iE NEGRO

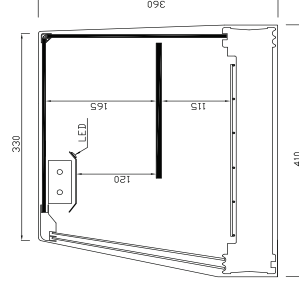

Modelo	Largo	Fondo	Alto	Parrillas	Plata/Nogal/Blanco/Negro
SHS-120iE	1216	410	360	1,5	1.720 €
SHS-150iE	1566	410	360	2	1.760 €
SHS-200iE	1926	410	360	3	1.950 €





Plata - Nogal - Blanco - Negro - Acero Inoxidable



Modelo **FR i**

- Iluminación LED.
- Puertas correderas en metacrilato.
- Decoración de cristal curvo en negro.
- Cristal templado de seguridad.

**FR-6i PLATA**

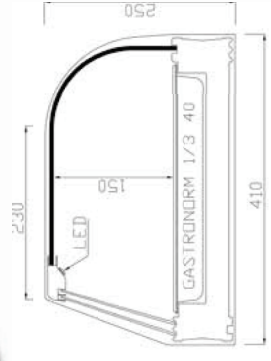

**SUPLEMENTO CURETA MELAMINA 1/3 h40**  
4 uds. 6 uds. 8 uds.  
48 € 72 € 96 €

Fabricación Especial  
**A MEDIDA**  
Pídanos Presupuesto

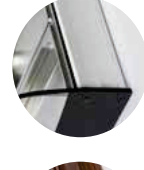

**FR-150i PLATA**

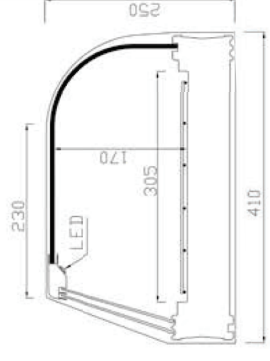
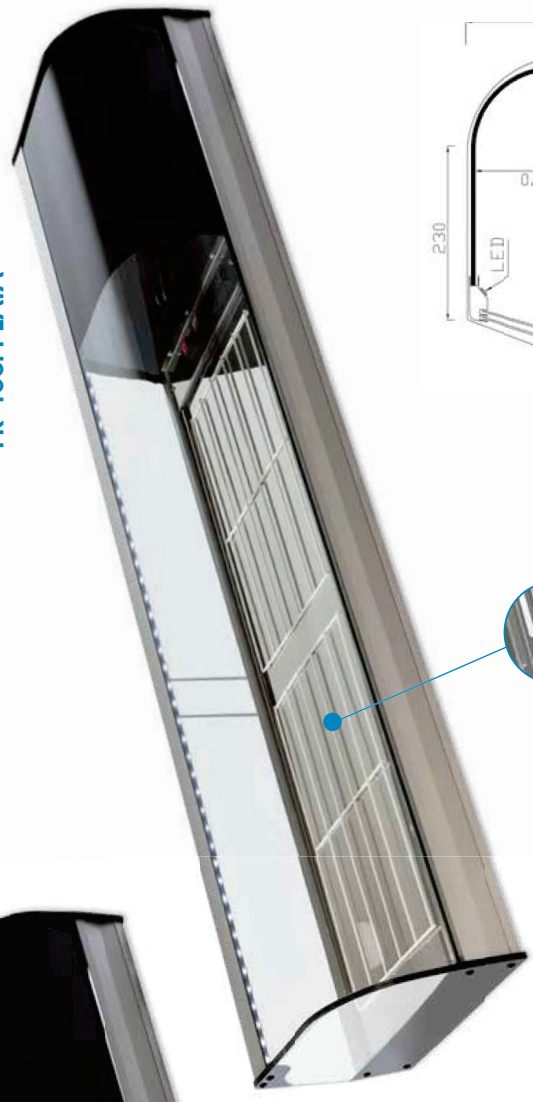

Modelo	Largo	Fondo	Alto	Cubetas (Incluidas)	Plata/Nogal/Blanco/Negro	Inox
FR-4i	1216	410	250	4	1.130 €	1.265 €
FR-6i	1566	410	250	6	1.200 €	1.345 €
FR-8i	1926	410	250	8	1.340 €	1.500 €

Modelo	Largo	Fondo	Alto	Parrillas (Incluidas)	Plata/Nogal/Blanco/Negro	Inox
FR-120i	1216	410	250	1.5	1.110 €	1.245 €
FR-150i	1566	410	250	2	1.180 €	1.325 €
FR-200i	1926	410	250	3	1.320 €	1.480 €





Estante intermedio



PLATA



NOGAL



BLANCO



NEGRO



ACERO INOXIDABLE

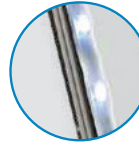

Iluminación **LED**

Modelo **FR iE**

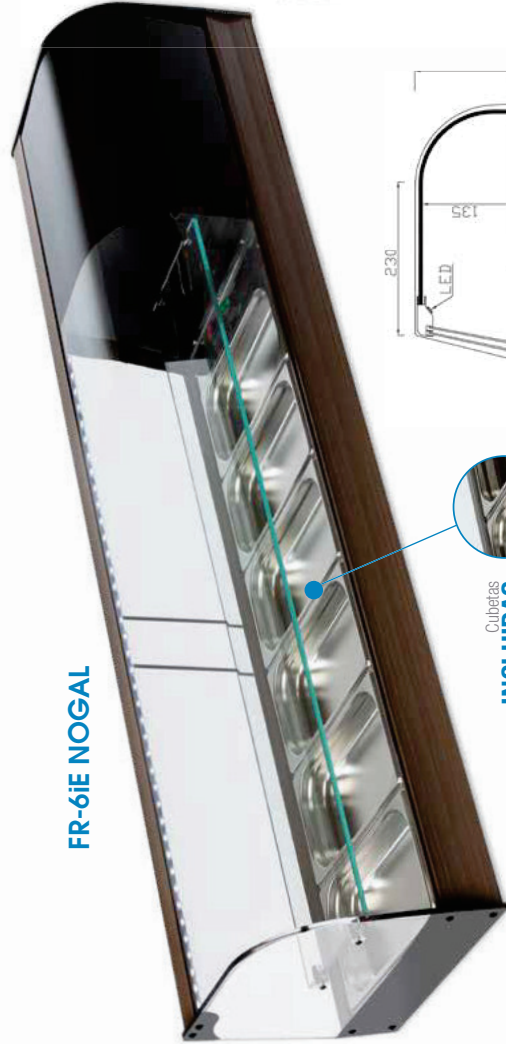

FR-6iE NOGAL



Cubetas **INCLUIDAS**

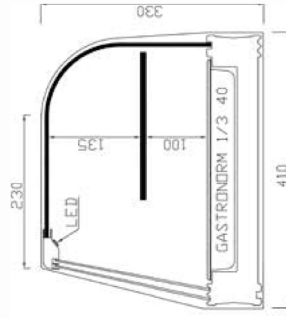

**SUPLEMENTO CUBETA**  
MELAMINA 1/3 h40  
4 uds. 6 uds. 8 uds.  
48 € 72 € 96 €

Fabricación Especial  
**A MEDIDA**  
Pídanos Presupuesto

FR-150iE NOGAL

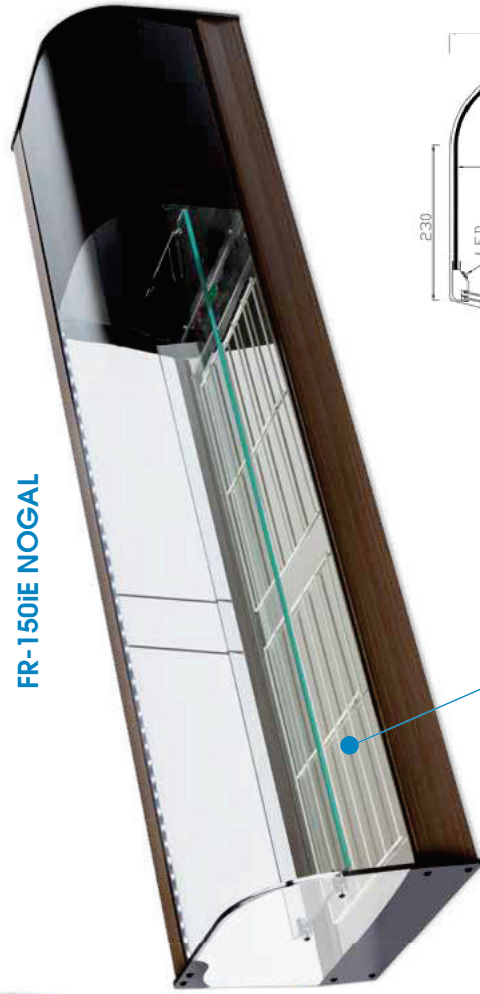

Parrillas **INCLUIDAS**

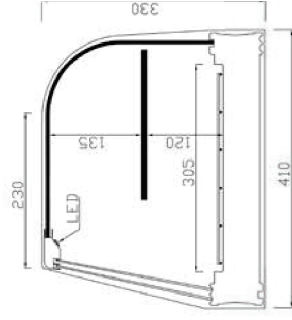

Modelo	Largo	Fondo	Alto	Cubetas (Incluidas)	Plata/Noгал/Blanco/ Negro	Inox
FR-4iE	1216	410	330	4	1.300 €	1.455 €
FR-6iE	1566	410	330	6	1.380 €	1.545 €
FR-8iE	1926	410	330	8	1.505 €	1.685 €

Modelo	Largo	Fondo	Alto	Parrillas (Incluidas)	Plata/Noгал/Blanco/ Negro	Inox
FR-120iE	1216	410	330	1.5	1.280 €	1.435 €
FR-150iE	1566	410	330	2	1.360 €	1.525 €
FR-200iE	1926	410	330	3	1.485 €	1.665 €



Plata - Nogal - Blanco - Negro - Acero inoxidable

Modelo  
**Iri**

- Iluminación LED.
- Puertas correderas en metacrilato.
- Decoración de cristal recto en negro.

**R-6i PLATA**

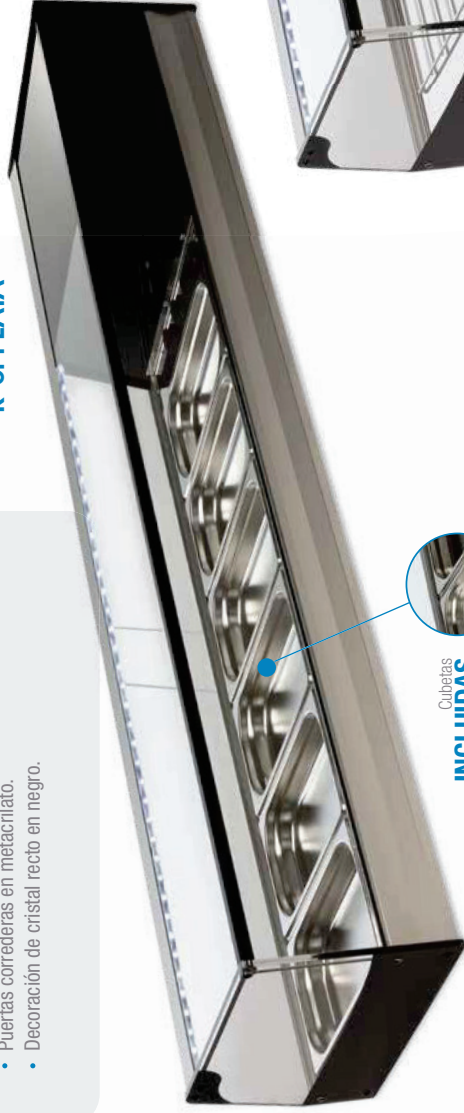

Cubetas  
**INCLUIDAS**



Fabricación Especial  
**A MEDIDA**  
Pídanos Presupuesto

**SUPLEMENTO CUBETA**  
MELAMINA 1/3 h.40  
4 uds. 6 uds. 8 uds. 10 uds.  
48 € 72 € 96 € 120 €

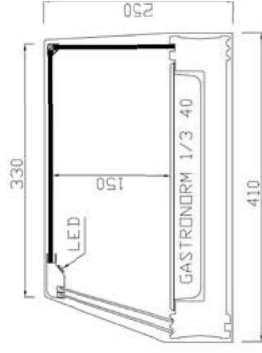

PLATA



NOGAL



BLANCO



NEGRO



ACERO  
INOXIDABLE

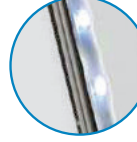

Iluminación  
**LED**



CRISTAL  
RECTO



Temperatura  
de Trabajo

+1°/+5°

Accesorios  
disponibles



Pag  
82

Especificaciones  
técnicas



Pag  
10

**R-150i PLATA**



Parrillas  
**INCLUIDAS**

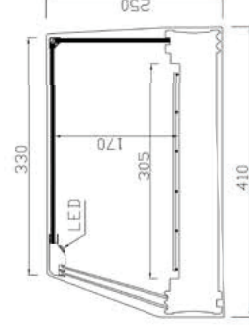

Modelo	Largo	Fondo	Alto	Parrillas (Incluidas)	Plata/Nogal/Blanco/Negro	Inox
R-4i	1216	410	250	4	1.095 €	1.225 €
R-6i	1566	410	250	6	1.170 €	1310 €
R-8i	1926	410	250	8	1.300 €	1.455 €
R-10i	2266	410	250	10	1.510 €	1.690 €
R-120i	1216	410	250	1.5	1.075 €	1.205 €
R-150i	1566	410	250	2	1.150 €	1.290 €
R-200i	1926	410	250	3	1.280 €	1.435 €
R-250i	2416	410	250	4	1.600 €	1.790 €

CRISTAL RECTO

Temperatura de Trabajo +19/+5°

Accesorios disponibles

Especificaciones técnicas

Pag 10

GRUPO INCORPORADO  
VITRINA REFRIGERADA

Estante intermedio

Modelo **RiE**



PLATA



NOGAL



BLANCO

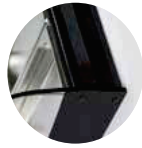

NEGRO



ACERO INOXIDABLE

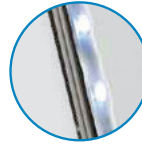

Iluminación **LED**

**R-4iE NOGAL**

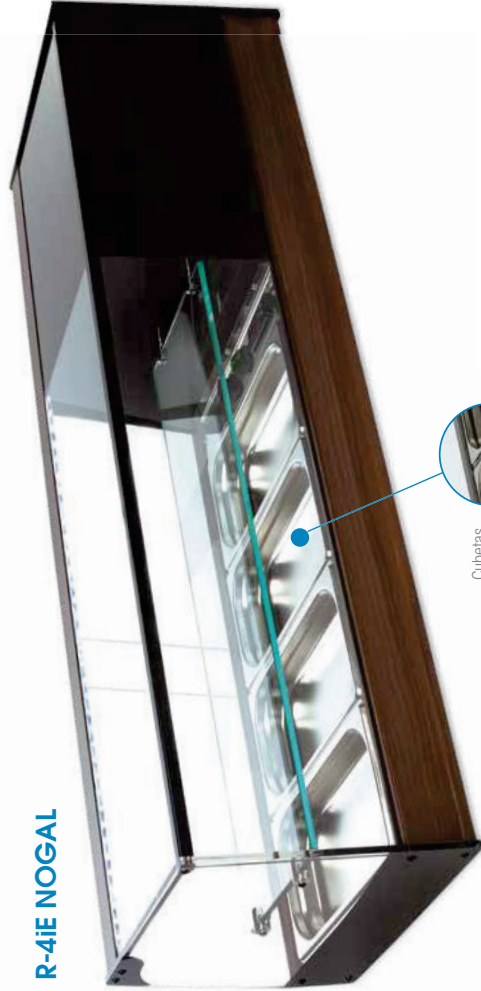

Cubetas **INCLUIDAS**

Fabricación Especial  
**A MEDIDA**  
Pídanos Presupuesto

**SUPLEMENTO CUBETA**  
MELAMINA 1/3 h40  
4 uds. 6 uds. 8 uds. 10 uds.  
48 € 72 € 96 € 120 €

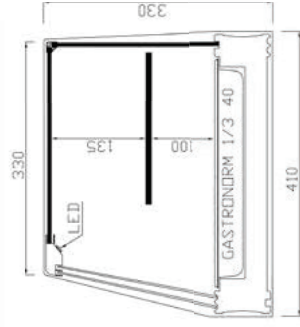

**R-120iE NOGAL**

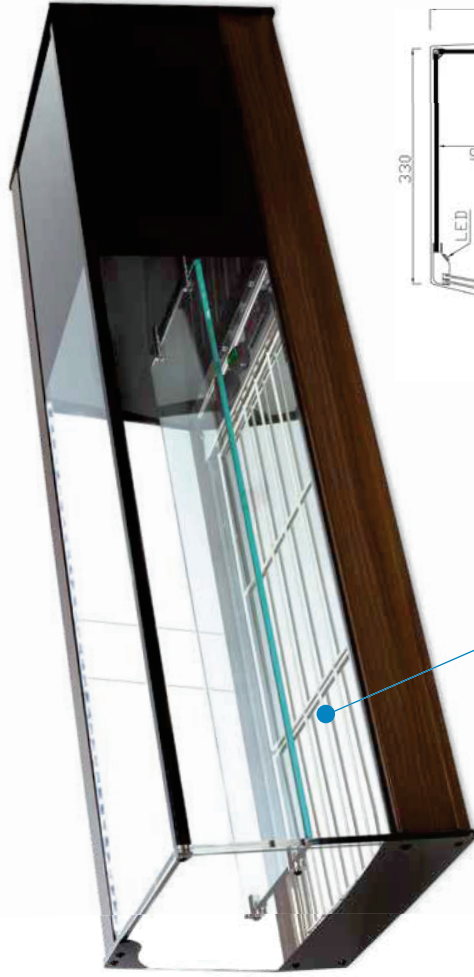

Parrillas **INCLUIDAS**

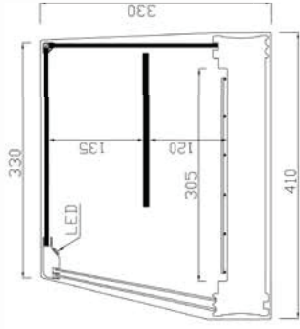

Modelo	Largo	Fondo	Alto	Cubetas (Incluidas)	Plata/Nogal/Blanco/Negro	Inox
R-4iE	1216	410	330	4	1.300 €	1.455 €
R-6iE	1566	410	330	6	1.380 €	1.545 €
R-8iE	1926	410	330	8	1.505 €	1.685 €
R-10iE	2266	410	330	10	1.850 €	2.070 €

Modelo	Largo	Fondo	Alto	Parrillas (Incluidas)	Plata/Nogal/Blanco/Negro	Inox
R-120iE	1216	410	330	1.5	1.280 €	1.435 €
R-150iE	1566	410	330	2	1.360 €	1.525 €
R-200iE	1926	410	330	3	1.485 €	1.665 €
R-250iE	2416	410	330	4	1.940 €	2.170 €



# GRUPO INCORPORADO VITRINA REFRIGERADA

Vitrina refrigerada Grupo incorporado Estante Abierto



CRISTAL  
CURVO



Temperatura  
de Trabajo  
+1°/+5°



Accesorios  
disponibles



Pag  
82

Especificaciones  
técnicas



Pag  
10

Modelo  
**ABF**

- Doble Iluminación LED.
- Puertas correderas en metacrilato hasta Estante intermedio.
- Cristal CURVO/RECTO

**ABF-6C PLATA**

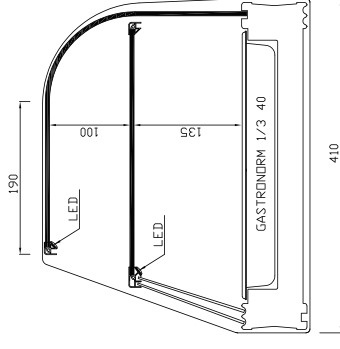

**ABF-150C PLATA**

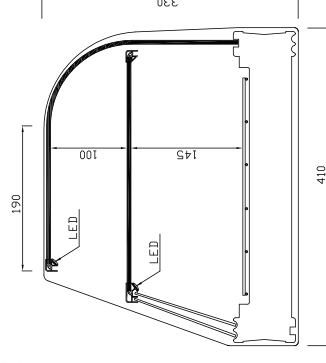

Fabricación Especial  
**A MEDIDA**

Pídanos Presupuesto

**SUPLEMENTO CUBETA**  
MELAMINA 1/3 h\*40  
4 uds. 6 uds. 8 uds.  
48 € 72 € 96 €



Modelo	Largo	Fondo	Alto	Cubetas (incluidas)	Plata/Nogal/Blanco/Negro	Inox	Modelo	Largo	Fondo	Alto	Parrillas (incluidas)	Plata/Nogal/Blanco/Negro	Inox
<b>ABF-4C</b>	1216	410	330	4	1.335 €	1.495 €	<b>ABF-120C</b>	1216	410	330	1,5	1.315 €	1.475 €
<b>ABF-6C</b>	1566	410	330	6	1.410 €	1.580 €	<b>ABF-150C</b>	1566	410	330	2	1.390 €	1.560 €
<b>ABF-8C</b>	1926	410	330	8	1.535 €	1.720 €	<b>ABF-200C</b>	1926	410	330	3	1.515 €	1.700 €



# GRUPO INCORPORADO VITRINA REFRIGERADA

CRISTAL  
RECTO



Temperatura  
de Trabajo  
+1°/+5°



Accesorios  
disponibles



Especificaciones  
técnicas



Pag  
10

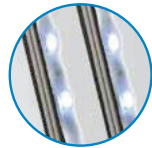

Doble  
Iluminación  
**LED**



PLATA



NOGAL



BLANCO



NEGRO



ACERO  
INOXIDABLE



**ABF-6R NEGRO**

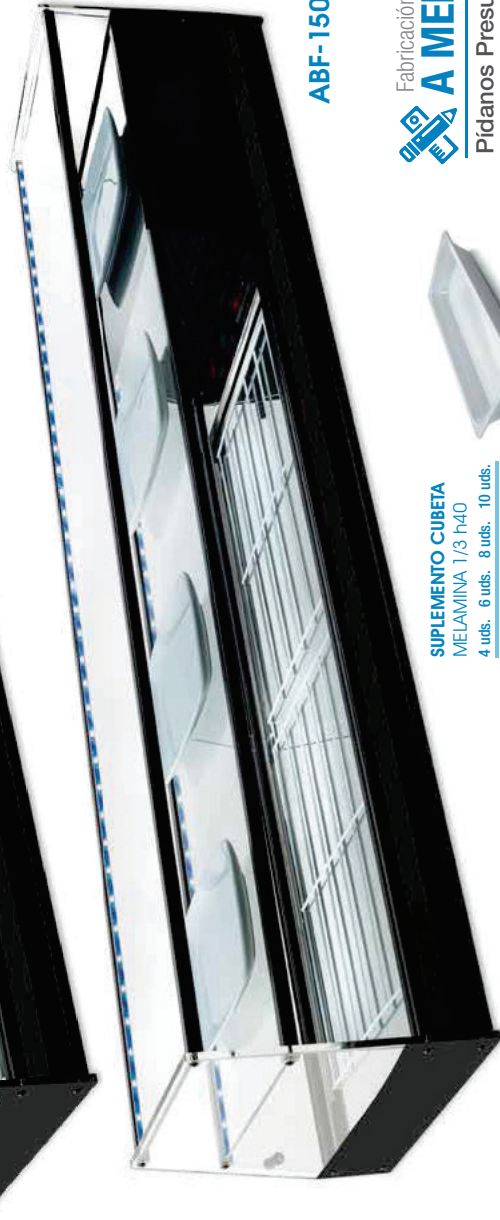
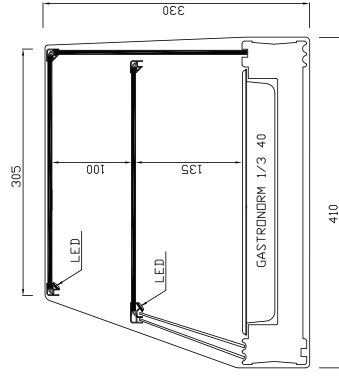

**ABF-150R NEGRO**

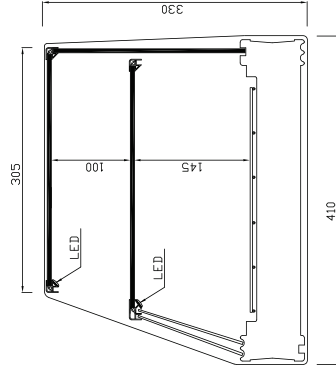

Fabricación Especial

**A MEDIDA**

Pídanos Presupuesto



**SUPLEMENTO CUBETA**  
MELAMINA 1/3 h40

4 uds. 6 uds. 8 uds. 10 uds.

48 € 72 € 96 € 120 €

Modelo	Largo	Fondo	Alto	Cubetas (Incluidas)	Plata/Nogal/Blanco/Negro	Inox
ABF-4R	1216	410	330	4	1.335 €	1.495 €
ABF-6R	1566	410	330	6	1.410 €	1.580 €
ABF-8R	1926	410	330	8	1.535 €	1.720 €
ABF10R	2266	410	330	10	1.825 €	2.040 €

Modelo	Largo	Fondo	Alto	Parrillas (Incluidas)	Plata/Nogal/Blanco/Negro	Inox
ABF-120R	1216	410	330	1.5	1.315 €	1.475 €
ABF-150R	1566	410	330	2	1.390 €	1.560 €
ABF-200R	1926	410	330	3	1.515 €	1.700 €
ABF-230R	2266	410	330	4	1.805 €	2.020 €



Modelo

**A2BF**

NOVEDAD

- Triple Iluminación LED.
- Puertas correderas en metacrilato hasta primer estante.
- Cristal RECTO
- 2 Estantes con Iluminación LED.
- Perfilera en color PLATA / NOGAL / BLANCO / NEGRO / ACERO INOXIDABLE

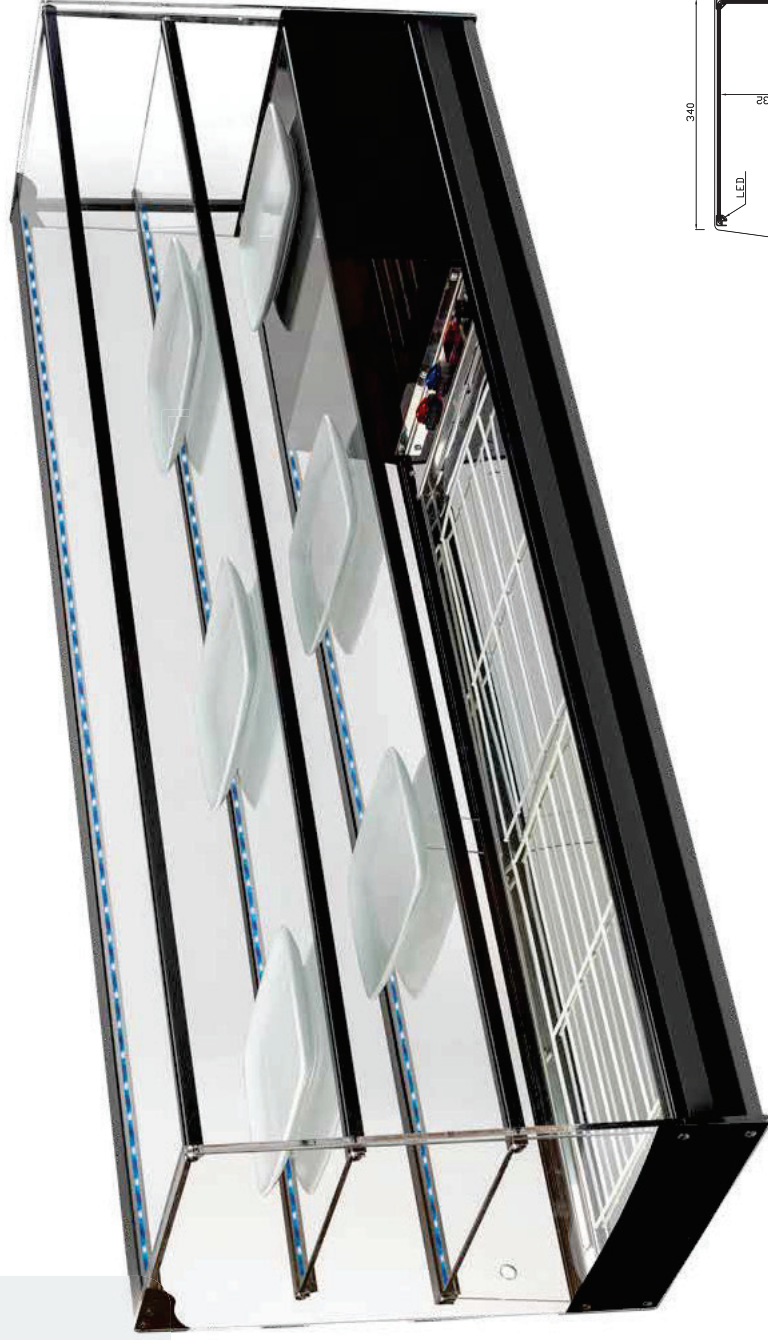
**A2BF-150**

Pídanos Presupuesto

**SUPLEMENTO CUBETA**

MELAMINA 1/3 R40

4 uds. 6 uds. 8 uds. 10 uds.

48 € 72 € 96 € 120€



Modelo	Largo	Fondo	Alto	Cubetas (Incluidas)	Plata/Nogal/Blanco/Negro	Inox
A2BF-4	1216	410	500	4	1.600 €	1.790 €
A2BF-6	1566	410	500	6	1.730 €	1.940 €
A2BF-8	1926	410	500	8	1.880 €	2.105 €
A2BF-10	2266	410	500	10	2.190 €	2.450 €

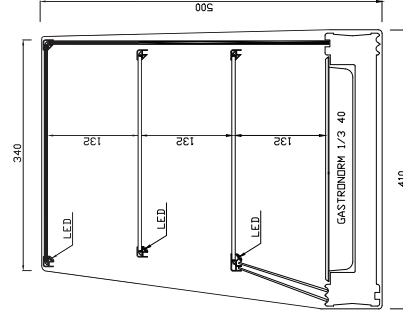

# GRUPO INCORPORADO VITRINA REFRIGERADA



PLATA

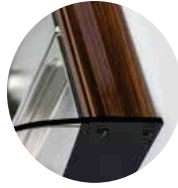

NOGAL



BLANCO



NEGRO



ACERO  
INOXIDABLE



Triple  
Iluminación  
**LED**

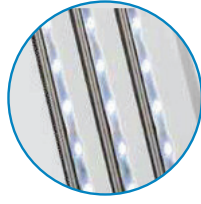

Fabricación Especial  
**A MEDIDA**  
Pídanos Presupuesto

**A2BF-150 zona trasera**

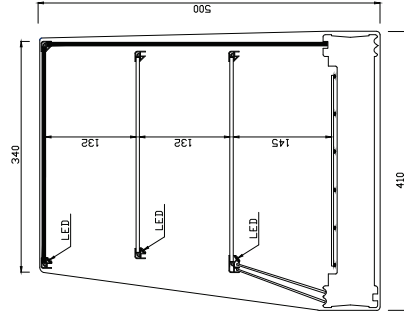

Modelo	Largo	Fondo	Alto	Parrillas (Incluidas)	Plata/Nogal/Blanco/Negro	Inox
A2BF-120	1216	410	500	1.5	1.580 €	1.770 €
A2BF-150	1566	410	500	2	1.710 €	1.920 €
A2BF-200	1926	410	500	3	1.860 €	2.085 €
A2BF-230	2266	410	500	4	2.170 €	2.430 €





CRISTAL CURVO



Temperatura de Trabajo



+1°/+5°



Accesorios disponibles



Pag 82



Especificaciones técnicas



Pag 10

Modelo  
**VN**

- Iluminación LED.
- Puertas correderas en metacrilato.
- Decoración de cristal curvo con VINILOS DECORATIVOS.
- Perfilera en aluminio color PLATA – NOGAL – BLANCO - NEGRO
- Cristal templado de seguridad.

### VN-6 NEGRO NUEVA YORK



Cubetas  
**INCLUIDAS**

#### SUPLEMENTO CUBETA

MELAMINA 1/3 h40

4 uds. 6 uds. 8 uds.

48 € 72 € 96 €

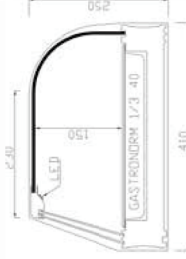

Modelo	Largo	Fondo	Alto	Cubetas (Incluidas)	Plata/Nogal/Blanco/Negro
VN-4	1216	410	250	4	1.160 €
VN-6	1566	410	250	6	1.230 €
VN-8	1926	410	250	8	1.370 €

### VN-150 BLANCO ANTYRTIDA



Parrillas  
**INCLUIDAS**

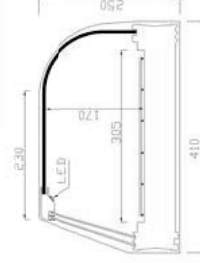

#### ¿QUIERE PERSONALIZAR SU VITRINA CON SU LOGOTIPO O FOTOGRAFÍA?

Mándenos su imagen con resolución mínima de 150 puntos de 450x450 mm y le personalizaremos su vitrina.

#### PRECIO: SUPLEMENTO DE 100€ SEGÚN MODELO ESTANDAR

Ejemplo: VN-6 + imagen personalizada: 1.180 €

Modelo	Largo	Fondo	Alto	Parrillas (Incluidas)	Plata/Nogal/Blanco/Negro
VN-120	1216	410	250	1.5	1.140 €
VN-150	1566	410	250	2	1.210 €
VN-200	1926	410	250	3	1.350 €





Iluminación  
**LED**

# GRUPO INCORPORADO VITRINA REFRIGERADA DECORADA

Estante intermedio

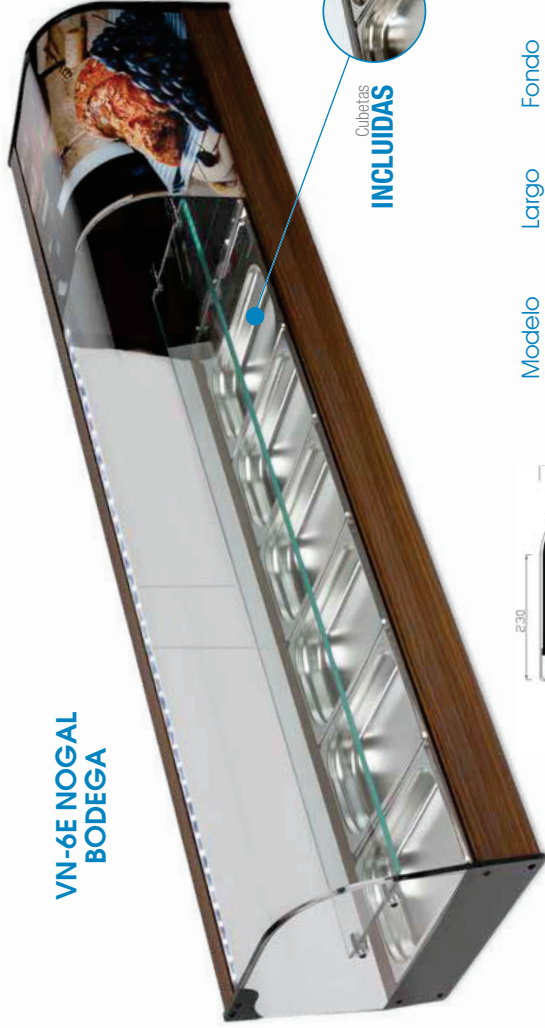

**VN-6E NOGAL  
BODEGA**

Fabricación Especial  
**A MEDIDA**  
Pídanos Presupuesto

**SUPLEMENTO CUBETA**  
MELAMINA 1/3 h40  
4 uds. 6 uds. 8 uds.  
48 € 72 € 96 €



Cubetas  
**INCLUIDAS**



**VN-150 PLATA  
TAILANDIA**

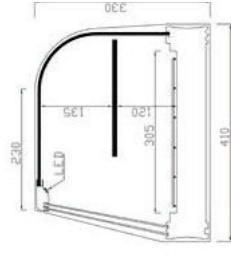
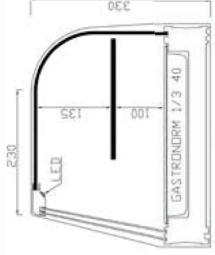
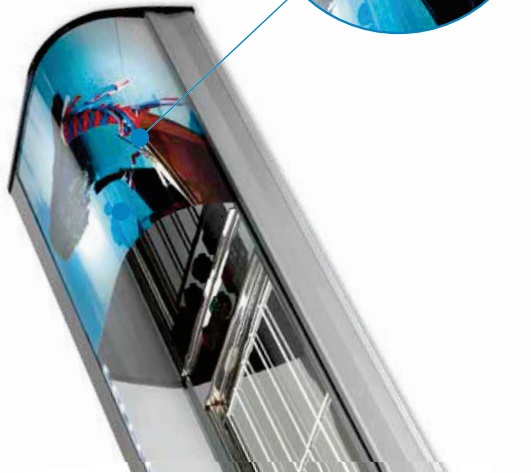

Modelo	Largo	Fondo	Alto	Cubetas (Incluidas)	Plata/Nogal/Blanco/Negro
<b>VN-4E</b>	1216	410	330	4	1.330 €
<b>VN-6E</b>	1566	410	330	6	1.410 €
<b>VN-8E</b>	1926	410	330	8	1.535 €

Modelo	Largo	Fondo	Alto	Parrillas (Incluidas)	Plata/Nogal/Blanco/Negro
<b>VN-120E</b>	1216	410	330	1.5	1.310 €
<b>VN-150E</b>	1566	410	330	2	1.390 €
<b>VN-200E</b>	1926	410	330	3	1.515 €

ELIJA UNA DECORACIÓN PARA SU VITRINA



ANTARTIDA



BODEGA



PUERTO



DESIERTO



MONTAÑA



PASARELA



PLAYA



TAILANDIA



NUOVA YORK



PARIS



Cristal Frontal hasta Nivel de Barra



Modelo  
**RCT**

- Cristal frontal hasta nivel de barra.
- Decoración de cristal en negro.
- Perfilera de aluminio en negro.
- Doble iluminación LED.
- Puertas correderas en metacrilato.

**RCT-6**

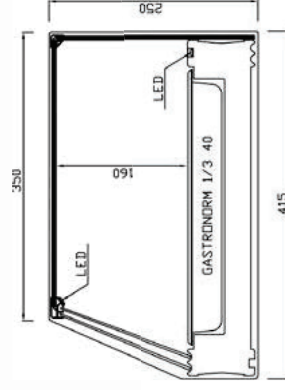

**SUPLEMENTO CUBETA**  
MELAMINA 1/3 h40  
4 uds. 6 uds. 8 uds.  
48 € 72 € 96 €

Modelo	Largo	Fondo	Alto	Cubetas	PVP
<b>RCT-4</b>	1216	415	250	4	1.155 €
<b>RCT-6</b>	1566	415	250	6	1.225 €
<b>RCT-8</b>	1926	415	250	8	1.365 €

**RCT-150**

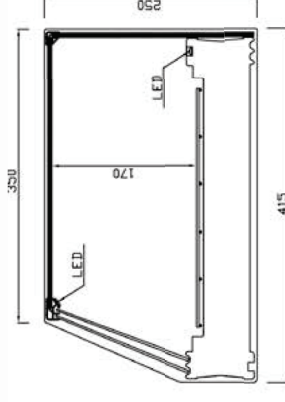
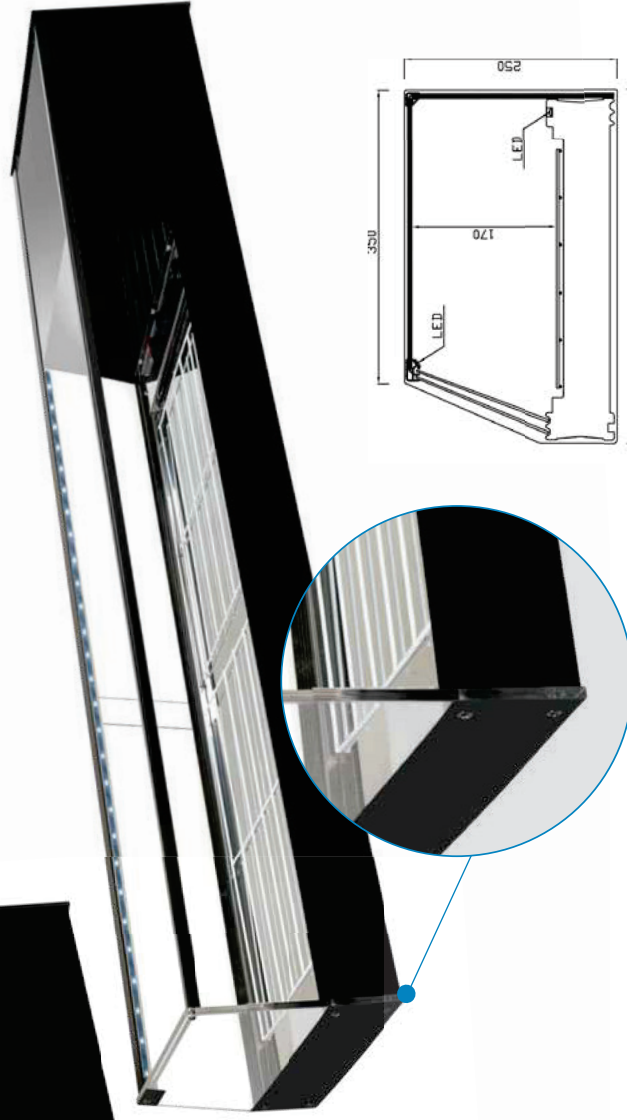

Modelo	Largo	Fondo	Alto	Parrillas	PVP
<b>RCT-120</b>	1216	415	250	1,5	1.135 €
<b>RCT-150</b>	1566	415	250	2	1.205 €
<b>RCT-200</b>	1926	415	250	3	1.345 €

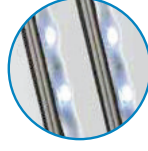

Doble  
iluminación  
**LED**

GRUPO INCORPORADO  
VITRINA REFRIGERADA



Modelo  
**RCT-E**

Estante intermedio

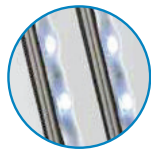

Doble  
Iluminación  
**LED**

**RCT-6E**



**RCT-150E**

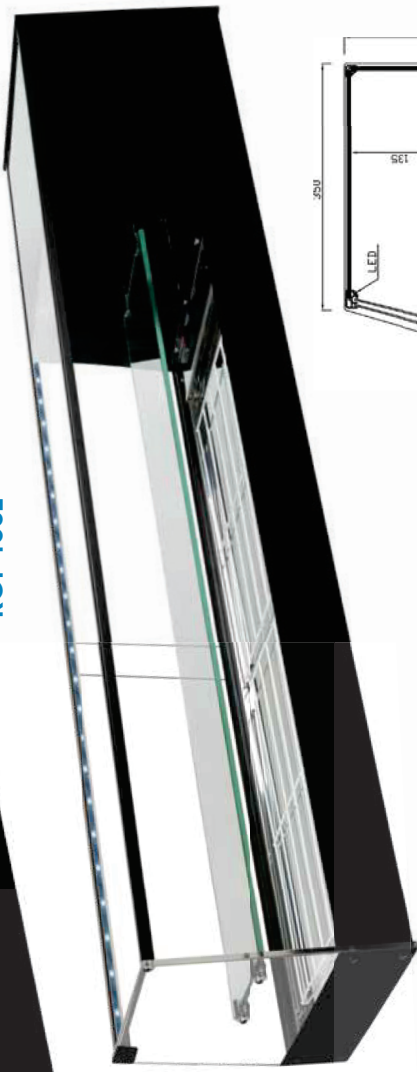

Fabricación Especial  
**A MEDIDA**  
Pídanos Presupuesto

**SUPLEMENTO CUBETA**  
MELAMINA 1/3 h40  
4 uds. 6 uds. 8 uds.  
48 € 72 € 96 €

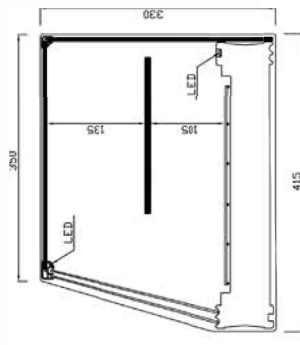
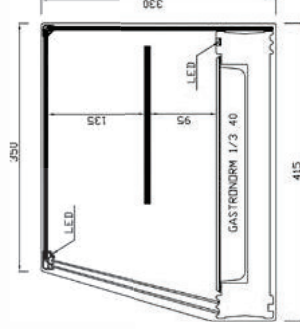

Modelo	Largo	Fondo	Alto	Cubetas	PVP
<b>RCT-4E</b>	1216	415	330	4	1.325 €
<b>RCT-6E</b>	1566	415	330	6	1.400 €
<b>RCT-8E</b>	1926	415	330	8	1.525 €

Modelo	Largo	Fondo	Alto	Parrillas	PVP
<b>RCT-120E</b>	1216	415	330	1,5	1.305 €
<b>RCT-150E</b>	1566	415	330	2	1.380 €
<b>RCT-200E</b>	1926	415	330	3	1.505 €





Modelo

**RCT-A**

- Doble iluminación LED.
- Puertas correderas en metacrilato hasta estante intermedio.
- Cristal Frontal sin perfilera.
- Decoración de cristal en negro.
- Perfilera en aluminio negro.

**RCT-6A**

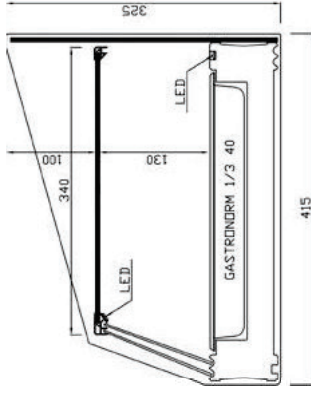
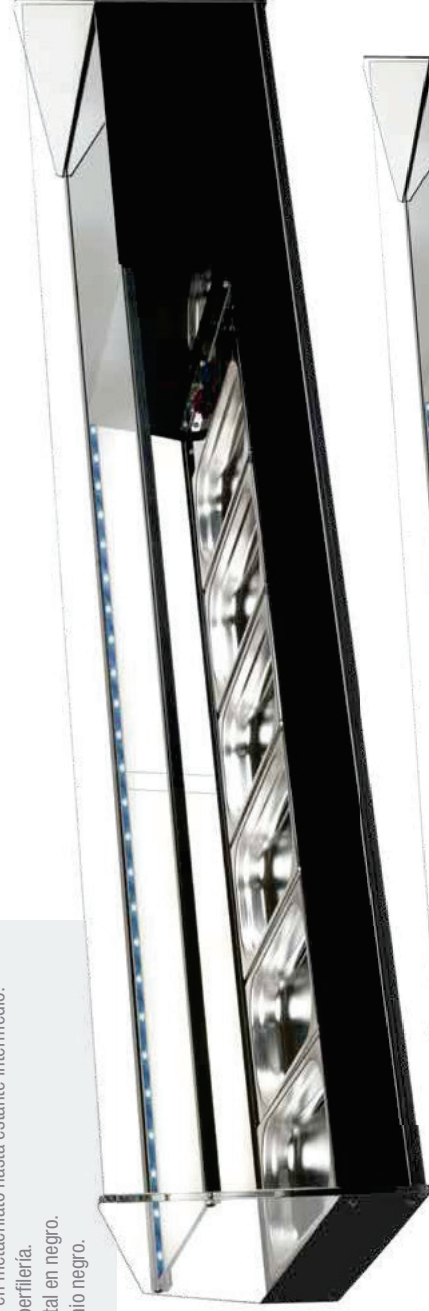

**RCT-150A**

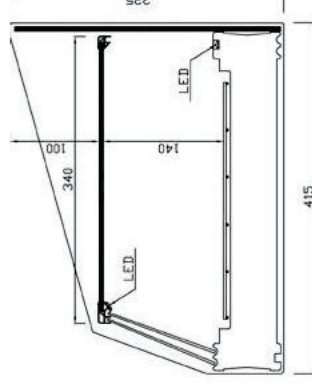
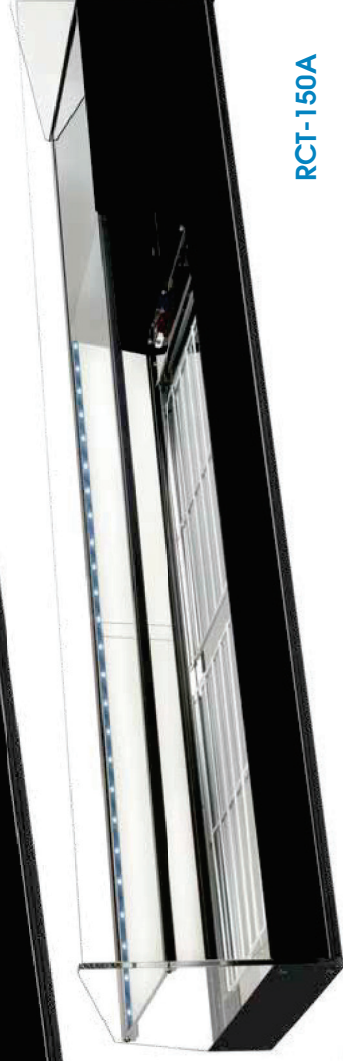

**SUPLEMENTO CUBETA**

MELAMINA 1/3 h40  
4 uds. 6 uds. 8 uds.

48 € 72 € 96 €



Modelo	Largo	Fondo	Alto	Cubetas	PVP
<b>RCT-4A</b>	1216	415	325	4	1.190 €
<b>RCT-6A</b>	1566	415	325	6	1.270 €
<b>RCT-8A</b>	1926	415	325	8	1.415 €

Modelo	Largo	Fondo	Alto	Parrillas	PVP
<b>RCT-120A</b>	1216	415	325	1,5	1.170 €
<b>RCT-150A</b>	1566	415	325	2	1.250 €
<b>RCT-200A</b>	1926	415	325	3	1.395 €

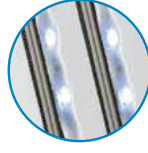

Doble  
iluminación  
**LED**

Modelo **MB6**

- Fabricada en Acero Inoxidable AISI-304.
- Puertas correderas en metacrilato.
- Cristal Curvado Templado Radio 20.
- Bandejas de Melamina Blanca Gastronorm 1/3 h65.



Iluminación **LED**



**MB-6**

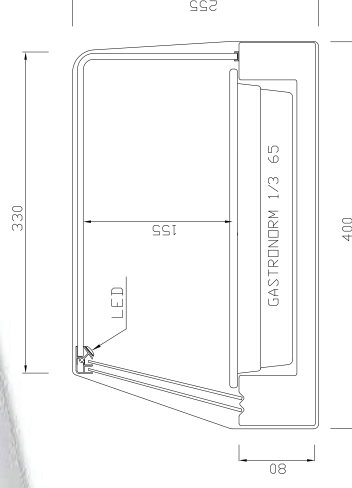

**GN 1/3 h65**



**VIDRIO CURVADO RADIO 20°**

Modelo	Largo	Fondo	Alto	Bandejas 1/3 h65	PVP
<b>MB-4</b>	1216	400	255	4	1.330 €
<b>MB-6</b>	1566	400	255	6	1.410 €
<b>MB-8</b>	1926	400	255	8	1.565 €



Decoración total en color negro

Modelo

## F BLACK

- Doble iluminación LED en zona superior y zona inferior.
- Puertas correderas en metacrilato.
- Decoración de cristal curvo en color NEGRO.
- Perfilera en aluminio color NEGRO.
- Cristal templado de seguridad.

F-BLACK4



Cubetas  
**INCLUIDAS**



Fabricación Especial  
**A MEDIDA**  
Pídanos Presupuesto

**SUPLEMENTO CUBETA**  
MELAMINA 1/3 T40  
4 uds. - 6 uds. - 8 uds.  
48 € - 72 € - 96 €

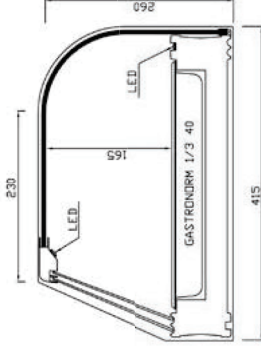

Modelo	Largo	Fondo	Alto	Cubetas incluidas	PVP
F-BLACK4	1216	415	260	4	1.225 €
F-BLACK6	1566	415	260	6	1.300 €
F-BLACK8	1926	415	260	8	1.450 €



CRISTAL  
CURVO



Temperatura  
de Trabajo

+1°/+5°



Accesorios  
disponibles

Pag  
82

Especificaciones  
técnicas

Pag  
10

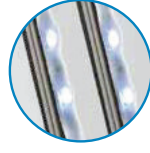

Doble  
iluminación  
**LED**



Iluminación  
**LED**

F-BLACK120

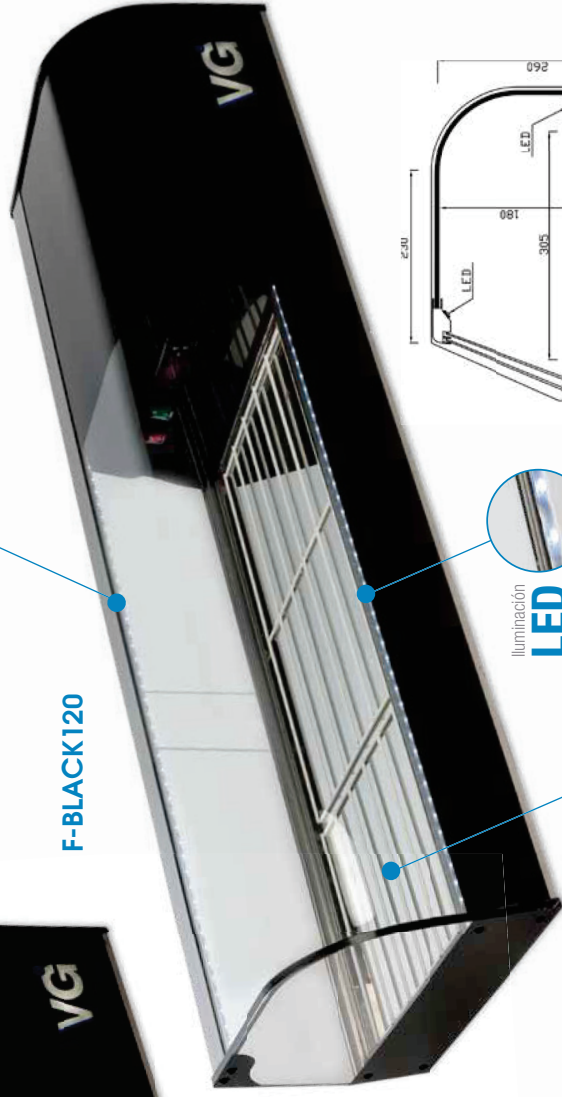

Iluminación  
**LED**



Parrillas  
**INCLUIDAS**

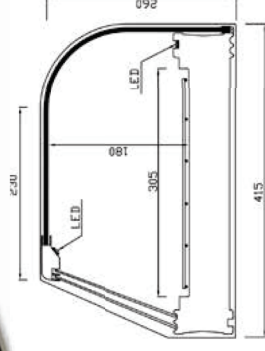

Modelo	Largo	Fondo	Alto	Parrillas incluidas	PVP
F-BLACK 120	1216	415	260	1.5	1.205 €
F-BLACK 150	1566	415	260	2	1.280 €
F-BLACK 200	1926	415	260	3	1.430 €



Temperatura de Trabajo



+1°/+5°

Pag 82



Especificaciones técnicas

Pag 10

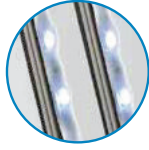

Doble iluminación LED

# GRUPO INCORPORADO VITRINA REFRIGERADA



Contrabarras de Cubetas



PLATA



NOGAL



BLANCO

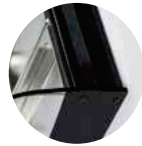

NEGRO

## Modelo CTB

- Doble iluminación LED.
- Puertas correderas de metacrilato.
- Trasera en espejo.
- Tapa en Acero inoxidable para colocar botellas, vajilla, accesorios, etc.

### SUPLEMENTO CUBETA

MELAMINA 1/3 T40

4 uds. 6 uds. 8 uds. 10 uds.

48 € 72 € 96 € 120 €



CTB-6 PLATA

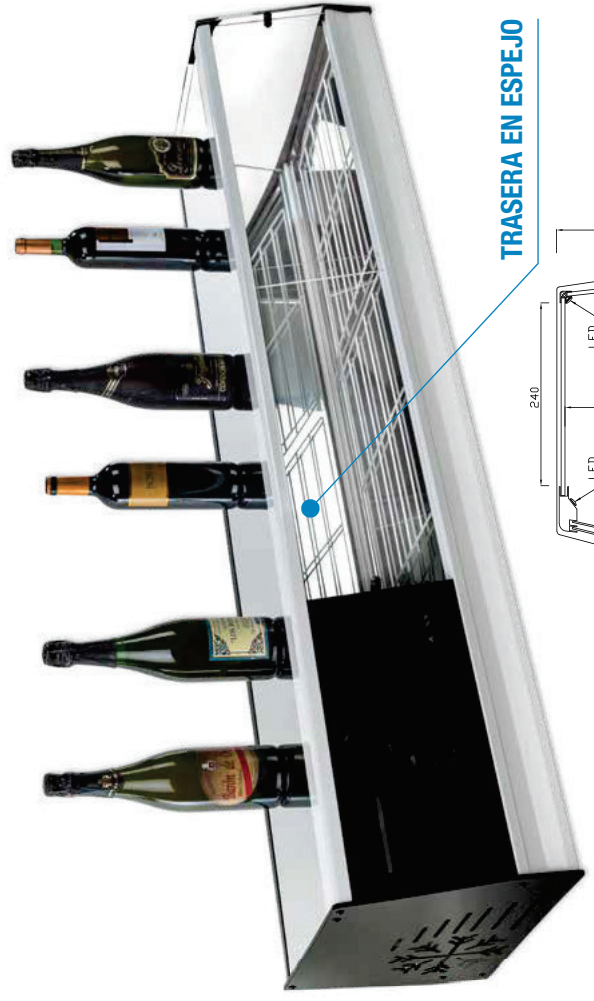
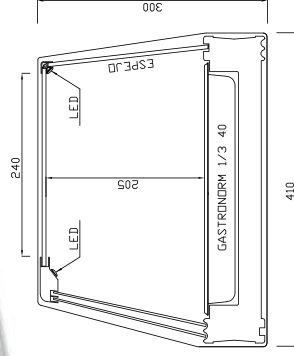

CTB-150 PLATA

TRASERA EN ESPEJO

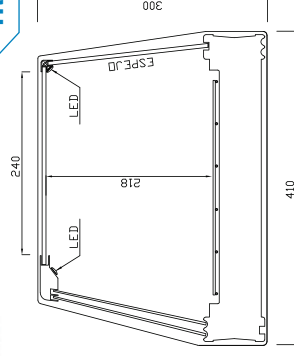

Modelo	Largo	Fondo	Alto	Cubetas (Incluidas)	Plata/Nogal/Blanco/Negro
CTB-4	1216	410	300	4	1.225 €
CTB-6	1566	410	300	6	1.310 €
CTB-8	1926	410	300	8	1.450 €
CTB-10	2266	410	300	10	1.675 €

Modelo	Largo	Fondo	Alto	Parrillas (Incluidas)	Plata/Nogal/Blanco/Negro
CTB-120	1216	410	300	1.5	1.205 €
CTB-150	1566	410	300	2	1.290 €
CTB-200	1926	410	300	3	1.430 €
CTB-230	2266	410	300	4	1.655 €



## Modelo DB Fi-C2

- Vitrina refrigerada de doble altura (FRÍO EN LAS DOS ALTURAS).
- ZONA INFERIOR : Cubetas Gastronorm 1/3 h40.
- ZONA SUPERIOR: Cubetas Gastronorm 1/3 h40.
- Triple Iluminación LED.
- Puertas Correderas.
- Perfilera en color Negro.

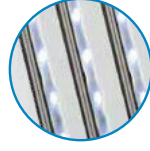

Triple  
Iluminación  
**LED**

**DB-Fi4C2**



Cubetas  
**INCLUIDAS**



**SUPLEMENTO CUBETA  
MELAMINA 1/3 h40**  
6 uds. 8 uds. 10 uds.  
72 € 96 € 120 €



Pídanos Presupuesto

Modelo	Largo	Fondo	Alto	Cubetas (nivel inferior)	Cubetas (nivel superior)	PVP
DB-Fi4C2	1216	420	480	4	6	2.030 €
DB-Fi6C2	1566	420	480	6	8	2.110 €
DB-Fi8C2	1926	420	480	8	10	2.360 €
DB-Fi10C2	2266	420	480	10	12	2.720 €

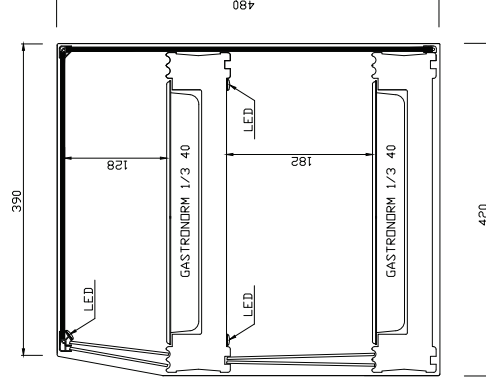

Modelo **DB Fi**

- Vitrina refrigerada de doble altura (FRÍO EN LAS DOS ALTURAS).
- ZONA INFERIOR : Cubetas Gastronorm 1/3 h40.
- ZONA SUPERIOR: Placa fría con parrillas incluidas.
- Platos no incluidos.
- Triple Iluminación LED.
- Puertas Correderas.
- Perfilera en color Negro.

DB-Fi6

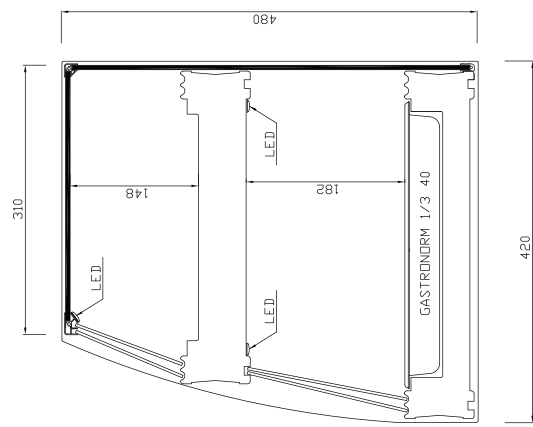

Fabricación Especial **A MEDIDA**

Pídanos Presupuesto

Modelo	Largo	Fondo	Alto	Cubetas (Incluidas)	Parrillas (Incluidas)	PVP
DB-Fi6	1566	420	480	6	3	2.050 €
DB-Fi8	1926	420	480	8	4	2.295 €
DB-Fi10	2266	420	480	10	5	2.640 €





GRUPO REMOTO







**Embraco**

- Compresor Hermético ALTA TEMPERATURA
- Monofásico 220V / 240V 50hz
- EMT6144U Potencia Frigorífica 343W A -10° C.V 1/5
- EMT6165U Potencia Frigorífica 478W A -10° C.V 1/4
- Temperatura de trabajo +1°C / +5°C
- Gas refrigerante R-290 PROPANO



**AKO**

- Control de temperatura mediante termostato electrónico digital con lectura constante y posibilidad de desescarche.

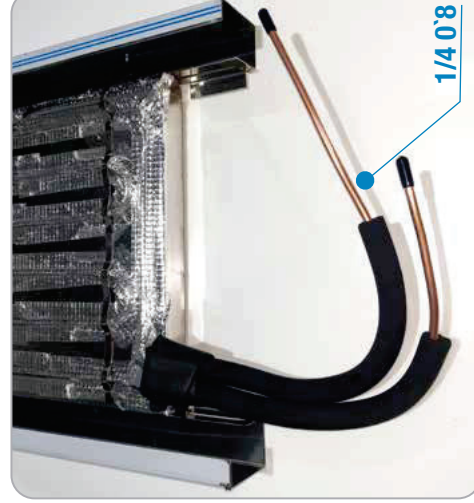

- Evaporador interior en cobre 1/4 espesor 0.8 mm
- Sujeción a la base con cinta adhesiva de maya y tira de chapa Inox soldada con puntos



- Bandeja Interior de vitrina en Chapa de Acero Inoxidable AISI 304 de 1 mm de grosor

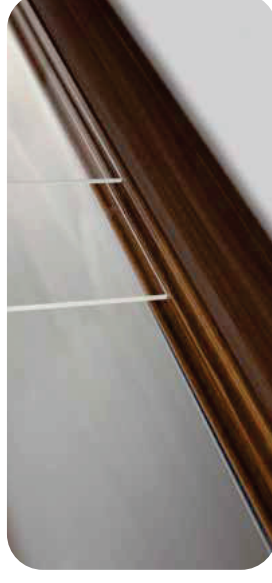

Perfil sanitario para una correcta limpieza de las guías correderas.

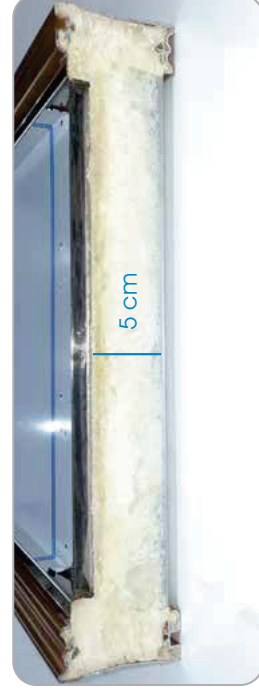

- Inyectado interior de vitrina en poliuretano libre de CFS de 5 cm



## MODELOS CON GRUPO REMOTO

Unidad condensadora remota protegida con chapa de acero galvanizado y paneles de metacrilato laterales para correcta visualización y protección de los componentes, totalmente conectada a la vitrina mediante tubo de 2.00 metros con carga de Gas R-290 incluida.



- Condensador Luve STVF47 y Compresor Embraco EMT 6144U GR1



- Condensador Luve STVF67 y Compresor Embraco EMT 6165U GR2

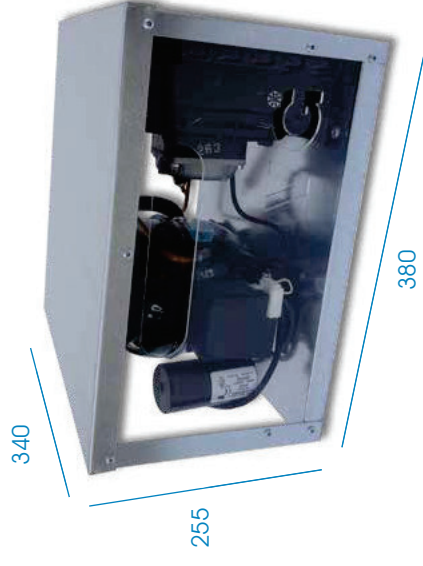

**i** SUPLEMENTO METRO ADICIONAL: 40€/metro lineal

**i** Elija sin coste ninguno el lado de salida de tubos y motor según camarero, a izquierda o derecha



Pag 44-46 **MAR-150**

Vidrio Curvo Altura 180



Pag 45-49 **MAR-F6R MAR-RCT**

Vidrio Recto Altura 180



Pag 50 **FR-6**

Cristal Curvo



Pag 51 **FR-120R NOGAL**

Vidrio Recto Altura 250



Pag 52 **FR-6E**

Vidrio Curvado con estante



Pag 53 **FR-120ER**

Vidrio Recto con estante



Pag 54-55 **20R-F200GR**

Vidrio Curvado Radio 20



Pag 56 **T-6**

Vidrio Recto hasta nivel barra



Pag 57 **T-120E**

Vidrio Recto hasta nivel barra con estante

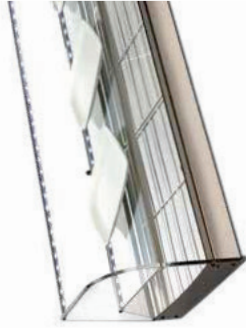





Pag 58  
**MAR-150ET**

Vitrina Curvada con estante abierto



Pag 59  
**MAR-F8ETR**

Vitrina Recta con estante abierto



Pag 60-61  
**MFR-6**

Acero Inoxidable



Pag 2-63  
**CST-120**

Acero Inoxidable para encastrar



Pag 64  
**PCH-150**

Acero Inoxidable para pinchos



Pag 65  
**VPI-150i**

Vitrina de pinchos



NOVEDAD

Pag 66-68  
**SHS-150GR SU-6**

Vitrina Sushi



Pag 69  
**SHS-6EGR**

Vitrina Sushi con estante



NOVEDAD

Pag 70-71  
**TR-3 150 FR-120ER**

Vitrina Sushi con 2 estantes



Pag 73  
**DB F**

Vitrina Doble Refrigerada



Pag 75-75  
**PF-120**

Vitrina Abierta

NOVEDAD



Pag 72,76  
**MIX-200 MIX-2F6**

Mixto FRIO+CALOR



Pag 77  
**PZ6**

Ingredientes



Pag 78-79  
**ING6 1/4CR**

Ingredientes



Pag 80-81  
**FCL-113**

Comidas para llevar



CRISTAL  
CURVOTemperatura  
de Trabajo

+1°/+5°

Accesorios  
disponiblesPag  
82Especificaciones  
técnicasPag  
40Modelo  
**MAR**

- Construida totalmente en Acero Inoxidable AISI-304.
- Unidad Condensadora Remota Totalmente protegida y conectada a la vitrina mediante tubo de 2.00 metros con carga de Gas R-290 incluida.
- Iluminación LED.
- Puertas abatibles en metacrilato.
- Cristal curvo fijo (modelos MAR240 – MAR300 2 cristales curvos).

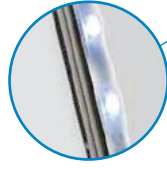
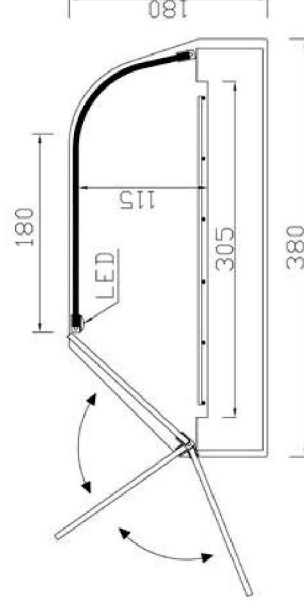
Iluminación  
**LED****MAR 150 INOX**Parrillas  
**INCLUIDAS**Fabricación Especial  
**A MEDIDA**

Pídanos Presupuesto

Colores disponibles:



PLATA



NOGAL



BLANCO



NEGRO

ACERO  
INOXIDABLE

Modelo	Largo	Fondo	Alto	Parrillas incluidas	PVP
<b>MAR-120</b>	1216	380	180	2	1.320 €
<b>MAR-150</b>	1516	380	180	3	1.390 €
<b>MAR-200</b>	2016	380	180	4	1.520 €
<b>MAR-240</b>	2416	380	180	5	2.060 €
<b>MAR-300</b>	3016	380	180	6	2.580 €



CRISTAL RECTO



Temperatura de Trabajo

+1°/+5°



Accesorios disponibles

Pag 82



Especificaciones técnicas

Pag 40

GRUPO REMOTO

VITRINA REFRIGERADA DE BANDEJA PLANA



Modelo **MAR R**

MAR 150 R INOX

Iluminación

**LED**

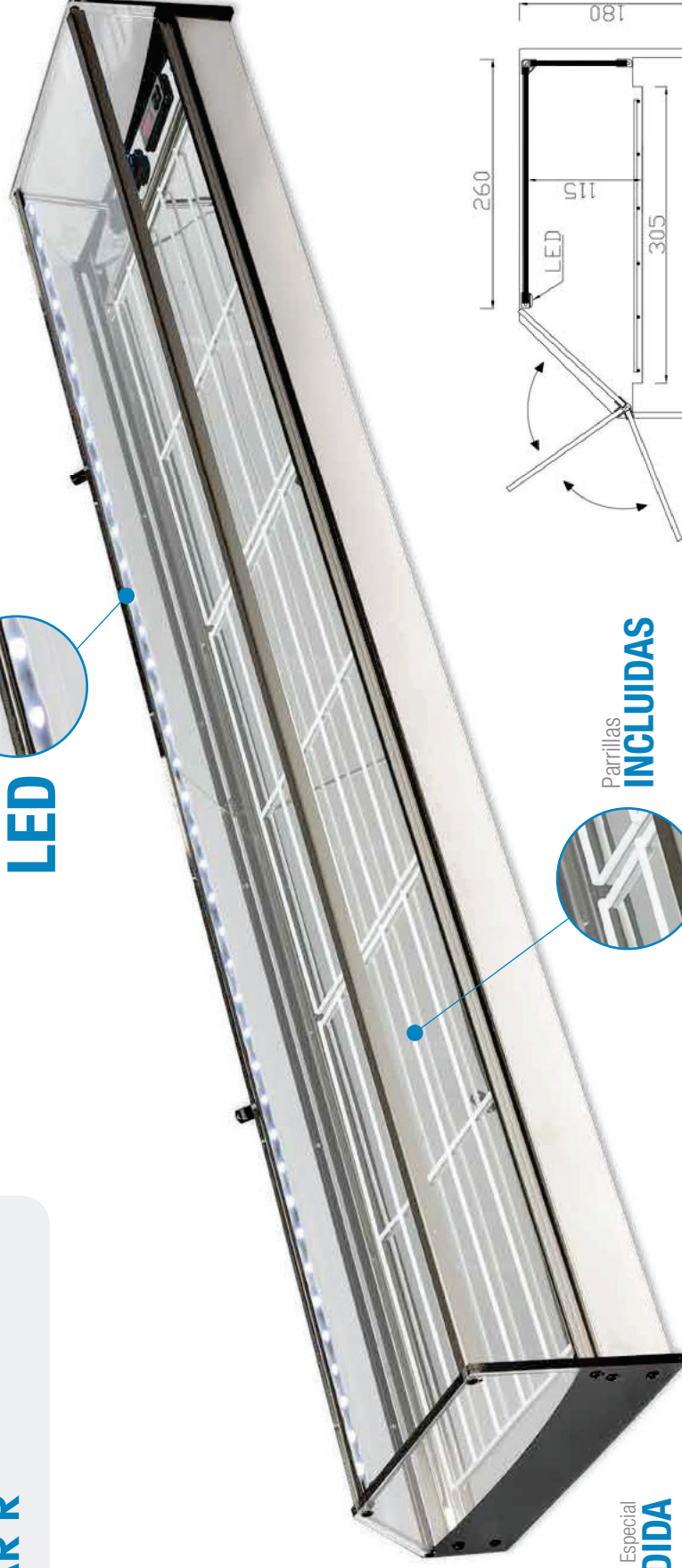
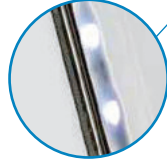

Parrillas **INCLUIDAS**

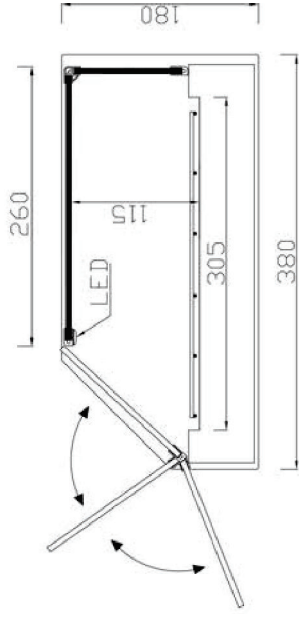

Fabricación Especial **A MEDIDA**

Pídanos Presupuesto

Colores disponibles:

Modelo	Largo	Fondo	Alto	Parrillas incluidas	PVP
MAR-120 R	1216	380	180	2	1.320 €
MAR-150 R	1516	380	180	3	1.390 €
MAR-200 R	2016	380	180	4	1.520 €
MAR-240 R	2416	380	180	5	2.060 €
MAR-300 R	3016	380	180	6	2.580 €



PLATA



NOGAL



BLANCO



NEGRO



ACERO INOXIDABLE



CRISTAL  
CURVOTemperatura  
de Trabajo

+1°/+5°

Especificaciones  
técnicasModelo  
**MAR F**

- Construida totalmente en Acero Inoxidable AISI-304.
- Cubetas Gastronorm 1/3 h40 incluidas (según modelo).
- Unidad Condensadora Remota Totalmente protegida y conectada a la vitrina mediante tubo de 2.00 metros con carga de Gas R-290 incluida.
- Iluminación LED.
- Puertas abatibles en metacrilato.
- Cristal curvo fijo (modelos MAR-F13 2 cristales curvos).



Iluminación

**LED****MAR F6 INOX**

Fabricación Especial

Pídanos Presupuesto

**SUPLEMENTO CUBETA**

MELAMINA 1/3 h40

6 uds. 8 uds. 10 uds. 13 uds. 16 und.

72 € 96 € 120 € 156 € 192 €

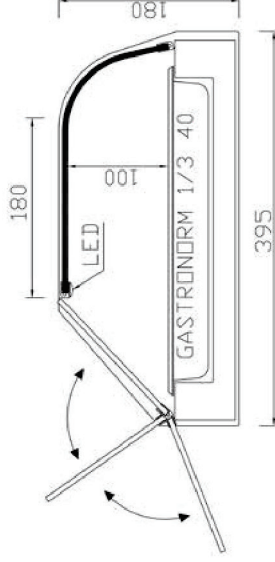
Cubetas  
**INCLUIDAS**

Colores disponibles:



PLATA



NOGAL



BLANCO



NEGRO

ACERO  
INOXIDABLE

Modelo	Largo	Fondo	Alto	Cubetas incluidas	PVP
<b>MAR-F6</b>	1156	395	180	6	1.370 €
<b>MAR-F8</b>	1516	395	180	8	1.425 €
<b>MAR-F10</b>	1866	395	180	10	1.565 €
<b>MAR-F13</b>	2416	395	180	13	2.090 €
<b>MAR-F16</b>	3016	395	180	16	2.585 €





Modelo  
**MAR FR**

MAR F6 R INOX



Iluminación  
**LED**

Cubetas  
**INCLUIDAS**



Fabricación Especial

Pídanos Presupuesto

**SUPLEMENTO CUBETA**

MELAMINA 1/3 H40  
6 uds. 8 uds. 10 uds. 13 uds. 16 unid.  
72 € 96 € 120 € 156 € 192 €

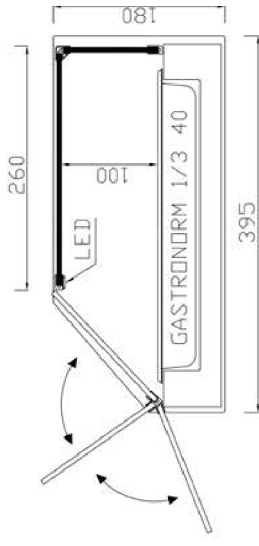

Modelo	Largo	Fondo	Alto	Cubetas incluidas	PVP
MAR-F6 R	1156	395	180	6	1.370 €
MAR-F8 R	1516	395	180	8	1.425 €
MAR-F10 R	1866	395	180	10	1.565 €
MAR-F13 R	2416	395	180	13	2.090 €
MAR-F16 R	3016	395	180	16	2.585 €

Colores disponibles:



PLATA



NOGAL



BLANCO



NEGRO



ACERO  
INOXIDABLE

GRUPO REMOTO

# VITRINA REFRIGERADA DE CUBETAS

Cristal frontal hasta nivel de barra



## Modelo MAR-RCT

- Cristal frontal hasta nivel de barra.
- Decoración de cristal en negro.
- Perfilaría de aluminio en negro.
- Doble iluminación LED.
- Puertas abatibles en metacrilato.
- Unidad condensadora Remota Totalmente protegida y conectada a la vitrina mediante tubo de 2,00 metros con carga de Gas R-290 incluida.

**MAR-RCT-6**

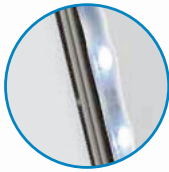

Iluminación  
**LED**



Cubetas  
**INCLUIDAS**



Fabricación Especial

Pídanos Presupuesto

**SUPLEMENTO CUBETA**  
MELAMINA 1/3 h40  
6 uds. 8 uds. 10 uds.  
72 € 96 € 120 €

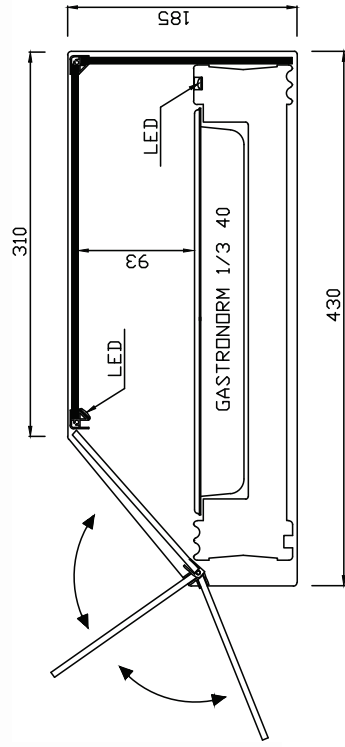

Modelo	Largo	Fondo	Alto	Cubetas incluidas	PVP
<b>MAR-RCT-6</b>	1156	430	185	6	1.410 €
<b>MAR-RCT-8</b>	1516	430	185	8	1.465 €
<b>MAR-RCT-10</b>	1866	430	185	10	1.605 €

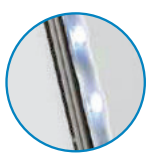

Iluminación  
**LED**

MAR-RCT 120



MAR-RCT 120  
ZONA TRASERA

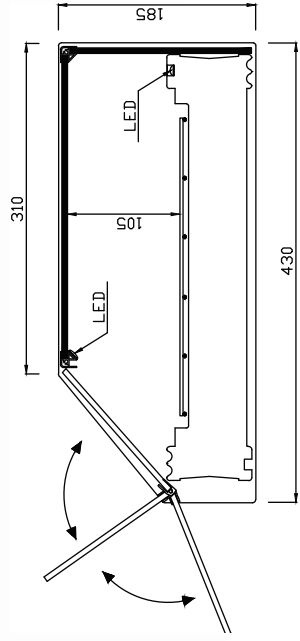

Modelo	Largo	Fondo	Alto	Parrillas incluidas	PVP
MAR-RCT-120	1216	430	185	2	1.390 €
MAR-RCT-150	1516	430	185	3	1.430 €
MAR-RCT-200	2016	430	185	4	1.630 €





Plata - Nogal - Blanco - Negro - Acero Inoxidable

**Modelo**  
**FR**

- Cubetas gastronorm 1/3 h40 o parrillas 450x280 incluidas en la vitrina.
- Unidad condensadora remota totalmente protegida y conectada a la vitrina mediante tubo de 2,00 metros con carga de gas.
- R-290 incluida.
- Iluminación LED.
- Puertas correderas en metacrilato.



PLATA



NOGAL



BLANCO



NEGRO

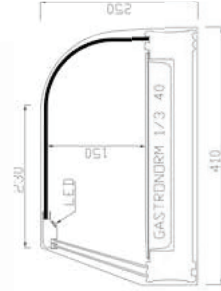
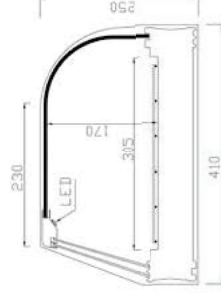

ACERO INOXIDABLE

Iluminación  
**LED****FR-6 PLATA**Cubetas  
**INCLUIDAS****SUPLEMENTO CUBETA**  
MELAMINA 1/3 h40  
4 uds. 6 uds. 8 uds. 10 uds.  
48 € 72 € 96 € 120 €**Pídanos Presupuesto****FR-120 PLATA**Parrillas  
**INCLUIDAS**

Modelo	Largo	Fondo	Alto	Cubetas (Incluidas)	Plata/Nogal/Blanco/Negro	Acero Inoxidable
FR-4	806	410	250	4	1.155 €	1.295 €
FR-6	1156	410	250	6	1.225 €	1.375 €
FR-8	1516	410	250	8	1.370 €	1.535 €
FR-10	1866	410	250	10	1.590 €	1.780 €

Modelo	Largo	Fondo	Alto	Parrillas (Incluidas)	Plata/Nogal/Blanco/Negro	Acero Inoxidable
FR-120	1216	410	250	2	1.190 €	1.335 €
FR-150	1516	410	250	3	1.350 €	1.515 €
FR-200	2016	410	250	4	1.600 €	1.790 €
FR-240	2416	410	250	5	1.900 €	2.130 €



Plata - Nogal - Blanco - Negro - Acero Inoxidable



PLATA



NOGAL



BLANCO



NEGRO



ACERO INOXIDABLE

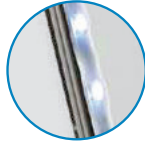

Iluminación LED

Modelo **FR-R**

- Cubetas gastronorm 1/3 h40 o parrillas 450 x 280 incluidas en la vitrina.
- Unidad condensadora remota totalmente protegida y conectada a la vitrina mediante tubo de 2.00 metros con carga de gas.
- R-290 incluida.
- Iluminación LED.
- Puertas correderas en metacrilato.

**FR-6R NOGAL**

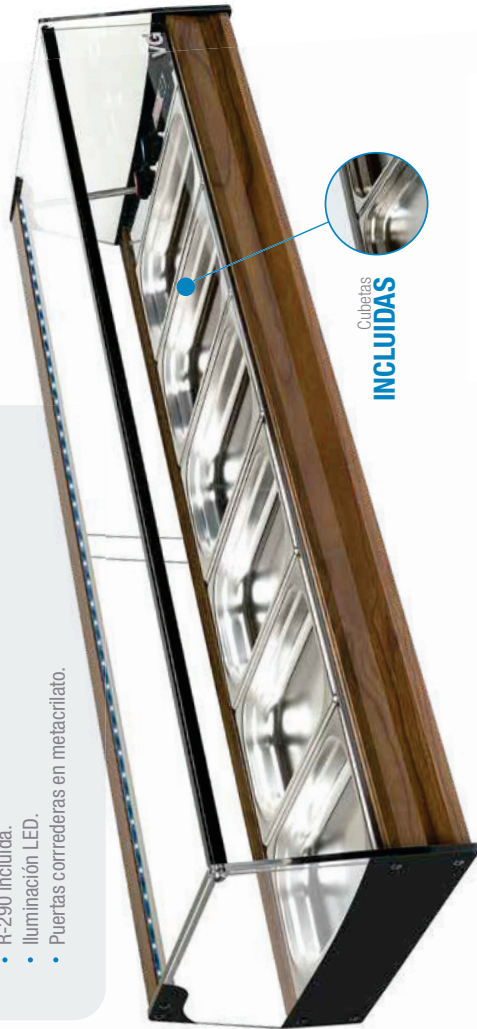

Cubetas INCLUIDAS

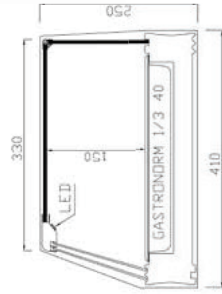

**SUPLEMENTO CUBETA MELAMINA 1/3 h40**  
 4 uds. 6 uds. 8 uds. 10 uds.  
 48 € 72 € 96 € 120 €

Modelo	Largo	Fondo	Alto	Cubetas (Incluidas)	Plata/Nogal/Blanco/Negro	Acero Inoxidable
FR-4R	806	410	250	4	1.155 €	1.295 €
FR-6R	1156	410	250	6	1.225 €	1.375 €
FR-8R	1516	410	250	8	1.370 €	1.535 €
FR-10R	1866	410	250	10	1.590 €	1.780 €

**FR-120R NOGAL**

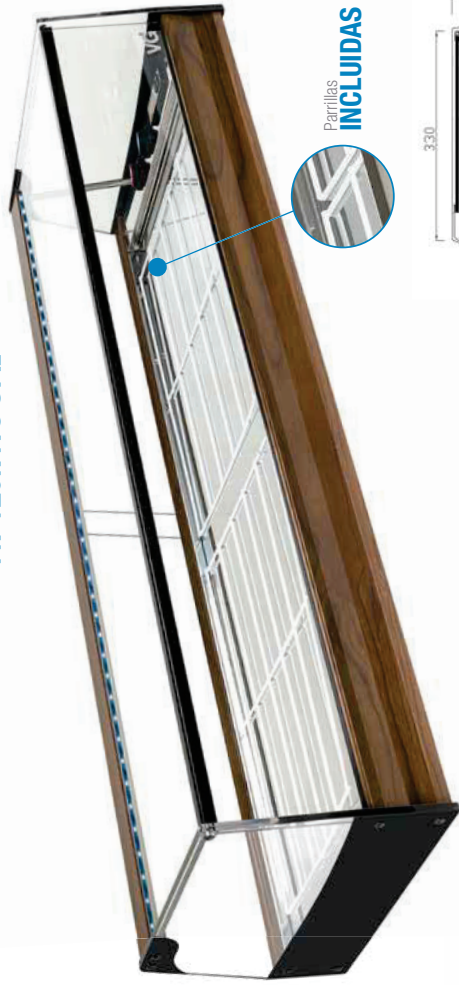

Parrillas INCLUIDAS

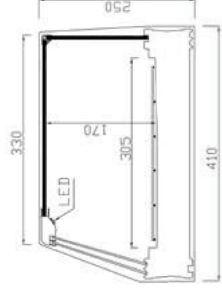

Modelo	Largo	Fondo	Alto	Parrillas (Incluidas)	Plata/Nogal/Blanco/Negro	Acero Inoxidable
FR-120R	1216	410	250	2	1.190 €	1.335 €
FR-150R	1516	410	250	3	1.350 €	1.515 €
FR-200R	2016	410	250	4	1.600 €	1.790 €
FR-240R	2416	410	250	5	1.900 €	2.130 €



CRISTAL  
CURVOTemperatura  
de Trabajo  
+1°/+5°Accesorios  
disponiblesPag  
82Especificaciones  
técnicasPag  
40

### Modelo FR-E

- Unidad condensadora remota totalmente protegida y conectada a la vitrina mediante tubo de 2.00 metros con carga de gas R-290 incluida.
- Iluminación LED.
- Puertas correderas en metacrilato.
- Estante intermedio.



PLATA



NOGAL



BLANCO

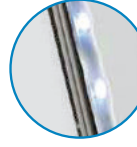

NEGRO

ACERO  
INOXIDABLEIluminación  
**LED**

### FR-6E PLATA

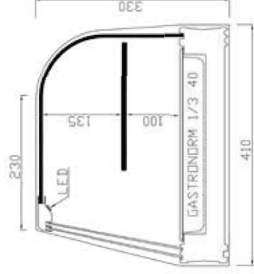
Cubetas  
**INCLUIDAS**

#### SUPLEMENTO CUBETA

MELAMINA 1/3 h.40  
4 uds. 6 uds. 8 uds. 10 uds.

48 € 72 € 96 € 120 €

### FR-120E PLATA

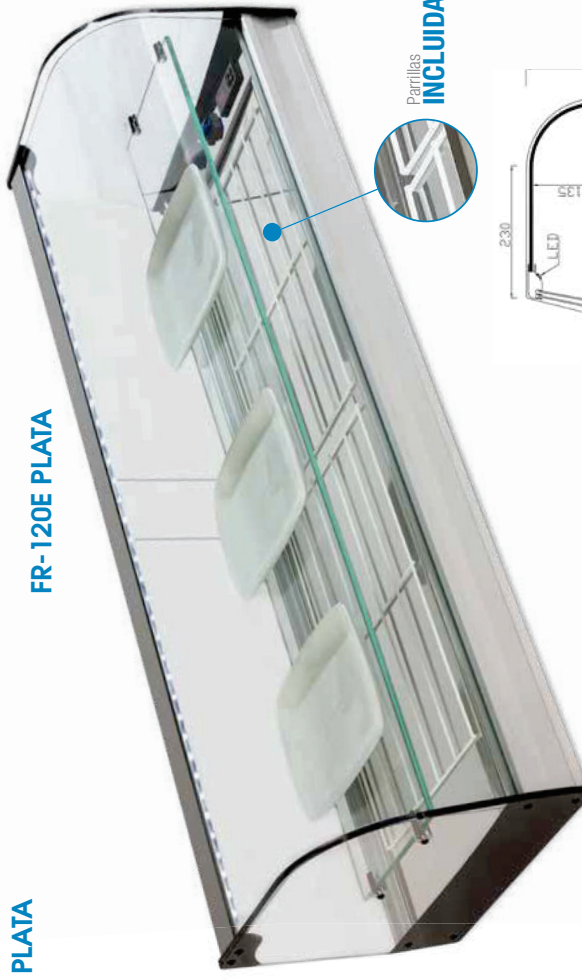
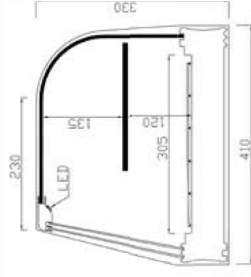
Parrillas  
**INCLUIDAS**

Modelo	Largo	Fondo	Alto	Cubetas (Incluidas)	Plata/Nogal/Blanco/Negro	Acero Inoxidable
FR-4E	806	410	330	4	1.325 €	1.485 €
FR-6E	1156	410	330	6	1.410 €	1.580 €
FR-8E	1516	410	330	8	1.575 €	1.770 €
FR-10E	1866	410	330	10	1.830 €	2.050 €

Modelo	Largo	Fondo	Alto	Parrillas (Incluidas)	Plata/Nogal/Blanco/Negro	Acero Inoxidable
FR-120E	1216	410	330	2	1.370 €	1.535 €
FR-150E	1516	410	330	3	1.550 €	1.735 €
FR-200E	2016	410	330	4	1.840 €	2.060 €
FR-240E	2416	410	330	5	2.190 €	2.450 €





Modelo **FR-ER**

- Unidad condensadora remota totalmente protegida y conectada a la vitrina mediante tubo de 2.00 metros con carga de gas R-290 incluida.
- Iluminación LED.
- Puertas correderas en metacrilato.
- Estante intermedio.



PLATA



NOGAL



BLANCO



NEGRO



ACERO INOXIDABLE

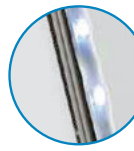

Iluminación **LED**

**FR-6ER NEGRO**

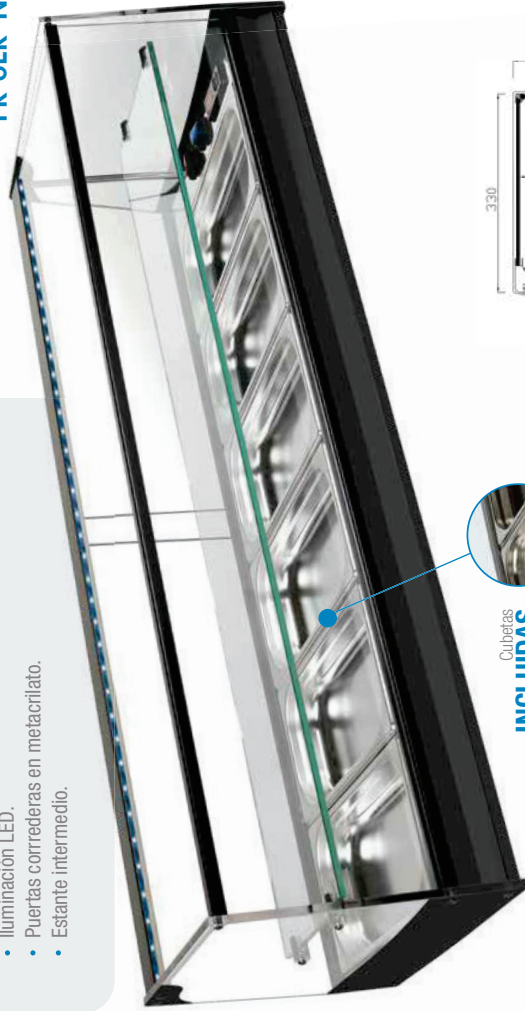

Cubetas **INCLUIDAS**

**SUPLEMENTO CUBETA**  
MELAMINA 1/3 1x40  
4 uds. 6 uds. 8 uds. 10 uds.  
48 € 72 € 96 € 120 €

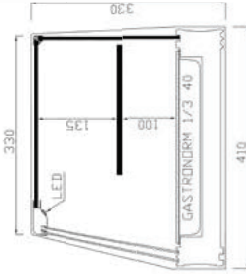

**FR-120ER NEGRO**

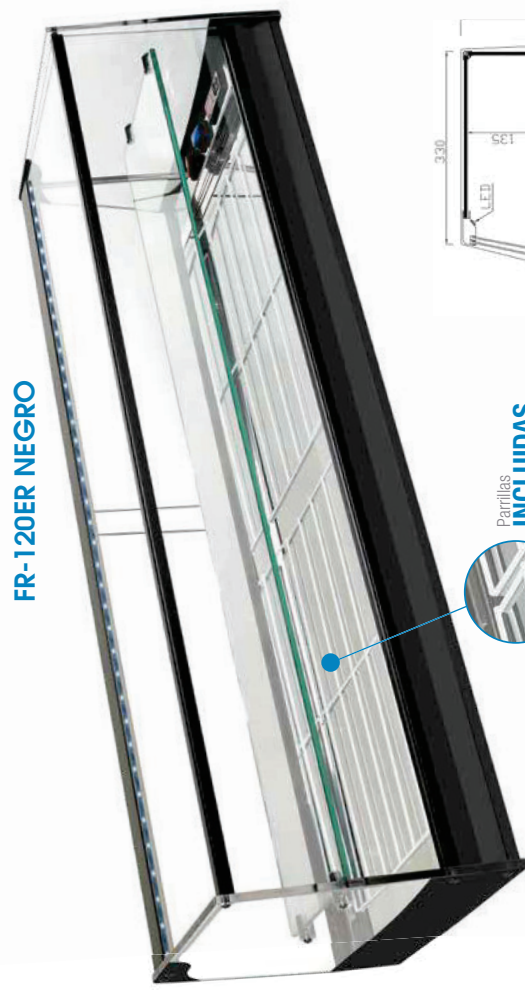

Parrillas **INCLUIDAS**

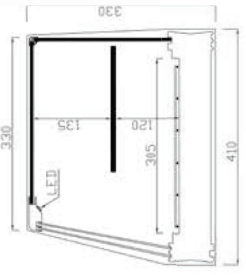

Modelo	Largo	Fondo	Alto	Cubetas (Incluidas)	Plata/Nogal/Blanco/Negro	Acero Inoxidable
FR-4ER	806	410	330	4	1.325 €	1.485 €
FR-6ER	1156	410	330	6	1.410 €	1.580 €
FR-8ER	1516	410	330	8	1.575 €	1.770 €
FR-10ER	1866	410	330	10	1.830 €	2.050 €

Modelo	Largo	Fondo	Alto	Parrillas (Incluidas)	Plata/Nogal/Blanco/Negro	Acero Inoxidable
FR-120ER	1216	410	330	2	1.370 €	1.535 €
FR-150ER	1516	410	330	3	1.550 €	1.735 €
FR-200ER	2016	410	330	4	1.840 €	2.060 €
FR-240ER	2416	410	330	5	2.190 €	2.450 €

Plata - Nogal - Blanco - Negro

CRISTAL  
CURVOTemperatura  
de Trabajo  
+1°/+5°Accesorios  
disponiblesEspecificaciones  
técnicas

## Modelo 20-GR

- Unidad condensadora remota totalmente protegida y conectada a la vitrina mediante tubo de 2.00 metros con carga de gas R-290 incluida.
- Iluminación LED.
- Puertas correderas en metacrilato.
- Cristal Curvado Templado Radio 20.

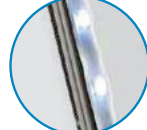
Iluminación  
**LED**

NEGRO



BLANCO



NOGAL

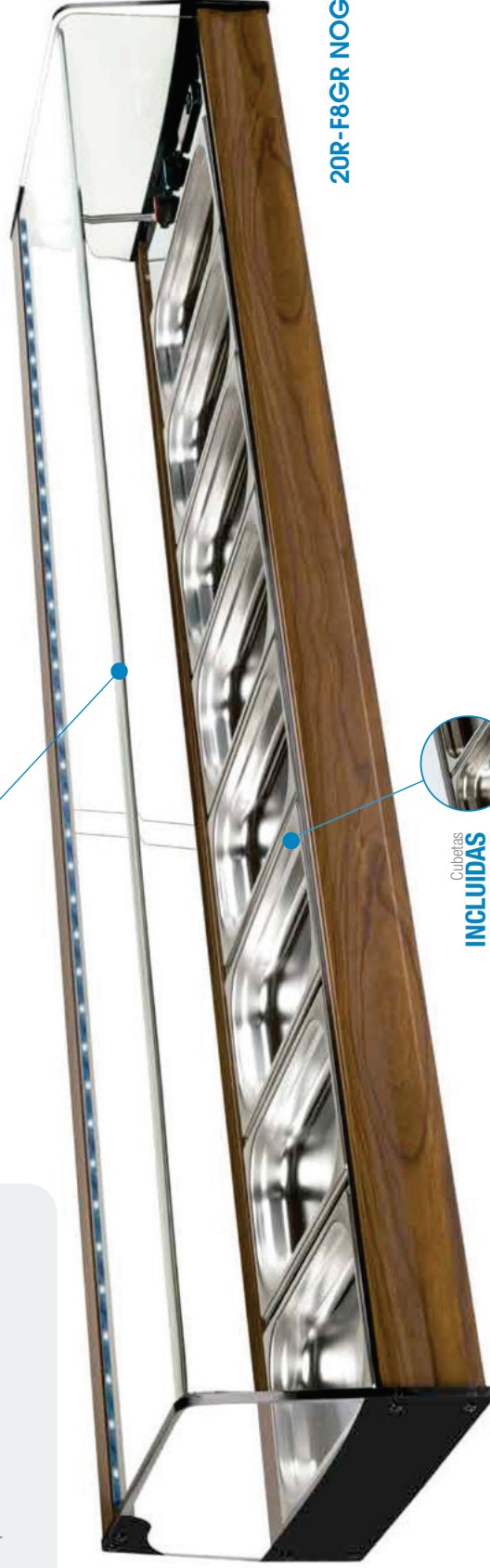

PLATA

**CRISTAL CURVO**  
RADIO 20°

20R-F8GR NOGAL

Cubetas  
**INCLUIDAS**
**SUPLEMENTO CUBETA**

MELAMINA 1/3 1x40

6 uds. 8 uds. 10 uds.

72 € 96 € 120 €



Modelo	Largo	Fondo	Alto	Cubetas (Incluidas)	Plata/Nogal/Blanco/Negro
20R-F6GR	1216	410	245	6	1.430 €
20R-F8GR	1566	410	245	8	1.515 €
20R-F10GR	1926	410	245	10	1.645 €

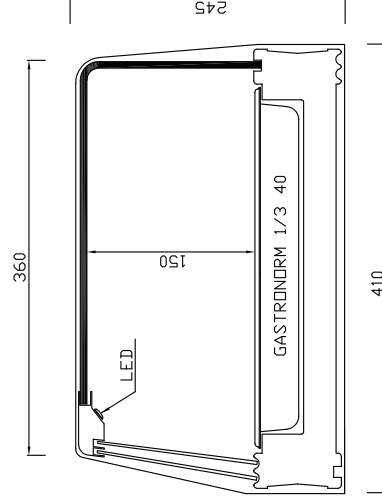

CRISTAL CURVADO RADIO 20°



CRISTAL  
CURVOTemperatura  
de Trabajo

+1°/+5°

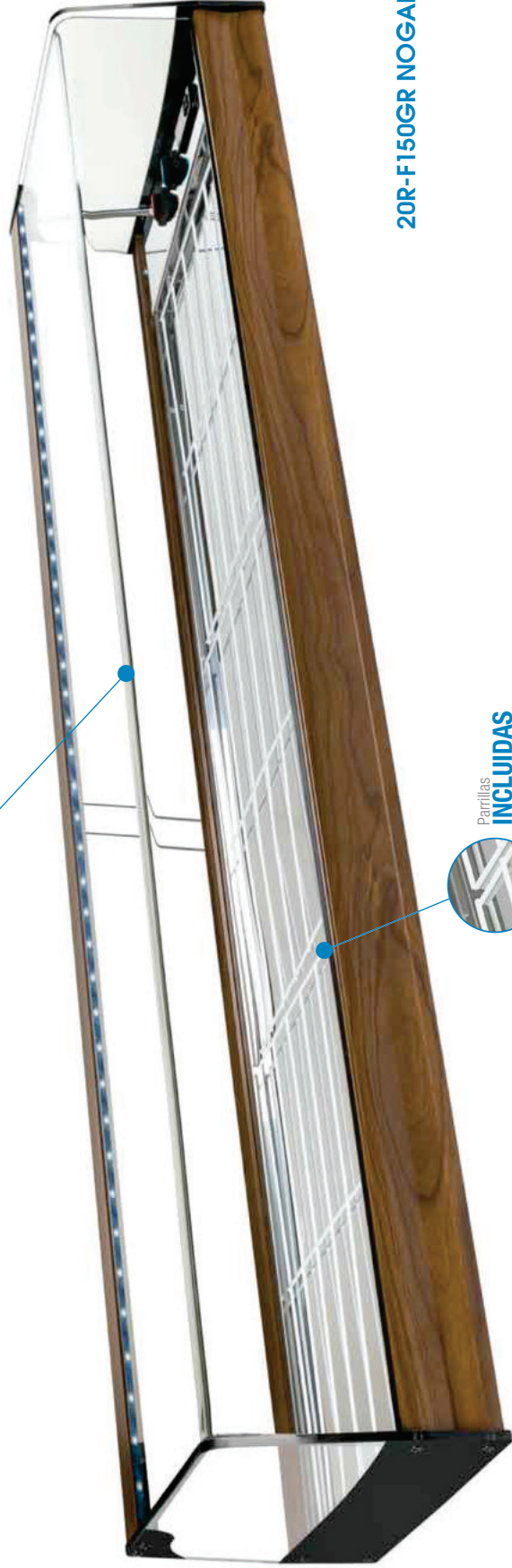
Accesorios  
disponiblesPag  
82Especificaciones  
técnicasPag  
40CRISTAL CURVO  
RADIO 20°Parrillas  
**INCLUIDAS**

20R-F150GR NOGAL

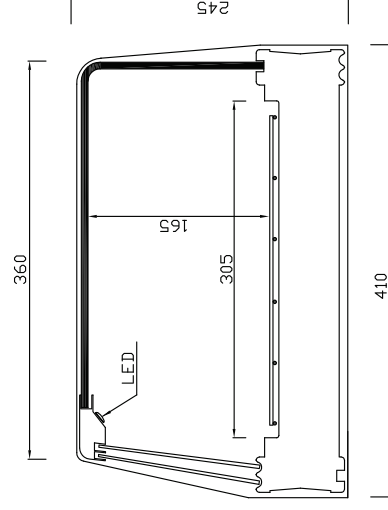

Modelo	Largo	Fondo	Alto	Parrillas	Plata/Nogal/Bianco/Negro
20R-F120GR	1216	410	245	2	1.410 €
20R-F150GR	1566	410	245	3	1.495 €
20R-F200GR	1926	410	245	4	1.625 €



Cristal frontal hasta nivel de barra

CRISTAL  
RECTOTemperatura  
de TrabajoAccesorios  
disponiblesEspecificaciones  
técnicasPag  
40

### Modelo

- Cubetas gastronorm 1/3 h40 o parrillas 450 x 280 incluidas en la vitrina.
- Unidad condensadora remota totalmente protegida y conectada a la vitrina mediante tubo de 2,00 metros con carga de gas R-290 incluida.
- Doble iluminación LED.
- Puertas correderas en metacrilato.

Doble  
Iluminación  
**LED**

T-6

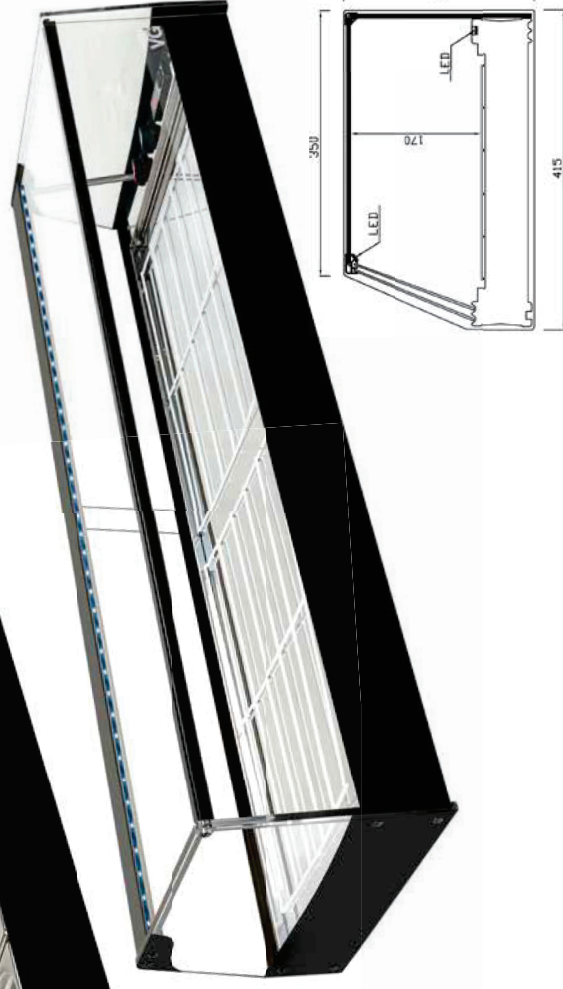
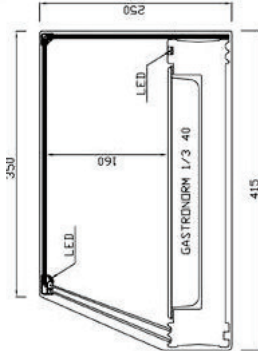
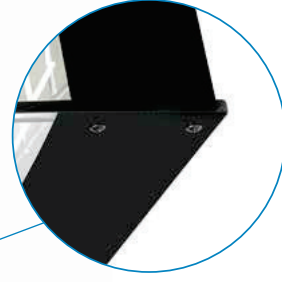

T-120

Fabricación Especial  
**A MEDIDA**  
Pídanos Presupuesto

Modelo	Largo	Fondo	Alto	Cubetas (Incluidas)	PVP
T-4	806	415	250	4	1.135 €
T-6	1156	415	250	6	1.200 €
T-8	1516	415	250	8	1.350 €
T-10	1866	415	250	10	1.555 €

Modelo	Largo	Fondo	Alto	Parrillas (Incluidas)	PVP
T-120	1216	415	250	2	1.170 €
T-150	1516	415	250	3	1.320 €
T-200	2016	415	250	4	1.560 €

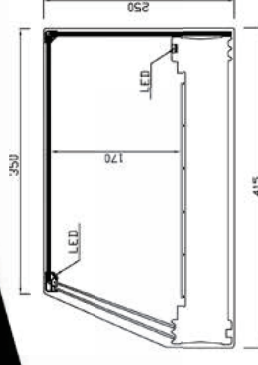

Modelo

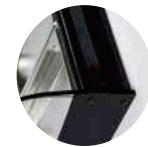
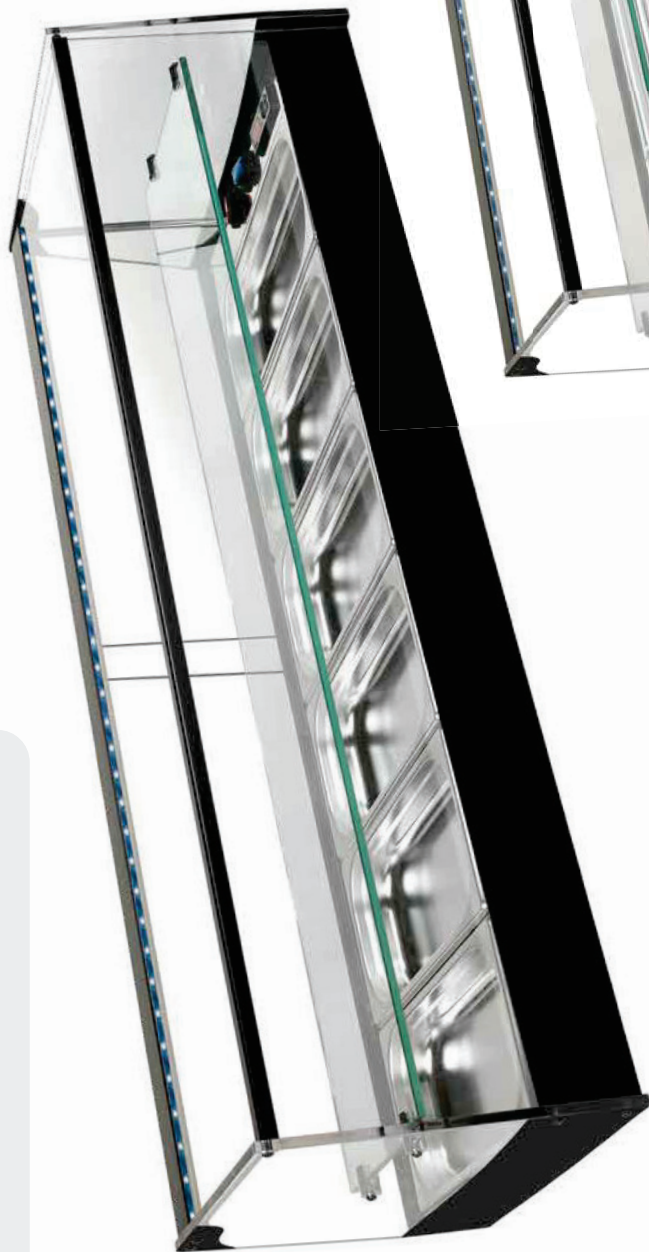
**T-E****T-6E**

NEGRO

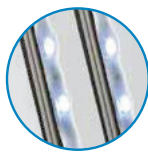
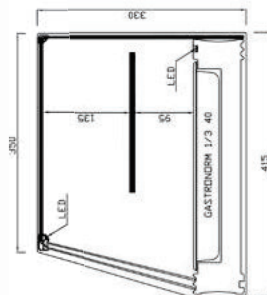
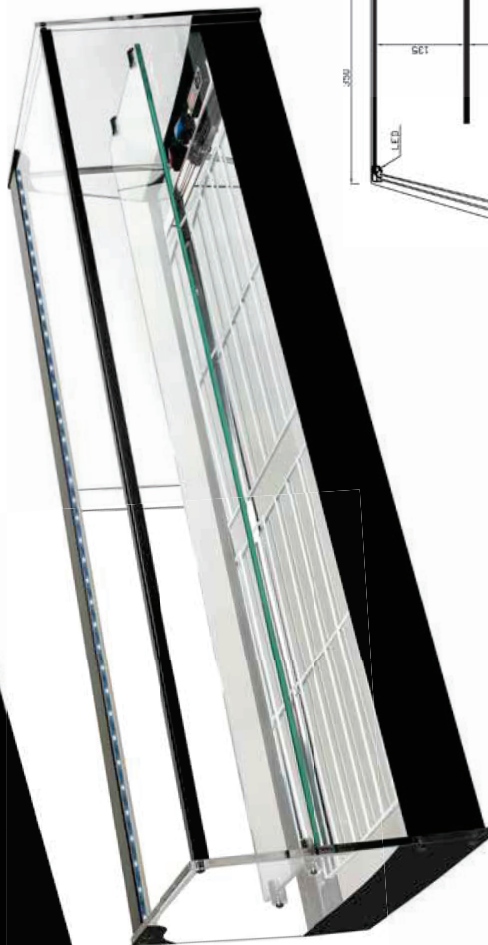
Doble  
Iluminación  
**LED****T-120E****SUPLEMENTO CUBETA**

MELAMINA 1/3 H40

4 uds. 6 uds. 8 uds. 10 uds.

48 € 72 € 96 € 120 €



Modelo	Largo	Fondo	Alto	Cubetas (Incluidas)	PVP
<b>T-4E</b>	806	415	330	4	1.300 €
<b>T-6E</b>	1156	415	330	6	1.385 €
<b>T-8E</b>	1516	415	330	8	1.535 €
<b>T-10E</b>	1866	415	330	10	1.845 €

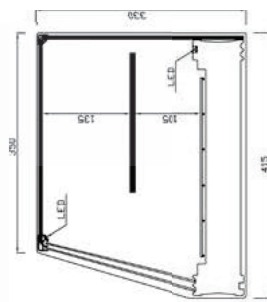

Modelo	Largo	Fondo	Alto	Parrillas (Incluidas)	PVP
<b>T-120E</b>	1216	415	330	2	1.335 €
<b>T-150E</b>	1516	415	330	3	1.515 €
<b>T-200E</b>	2016	415	330	4	1.785 €

Estante intermedio



Temperatura de Trabajo +1°/+5°



Accesorios disponibles



Especificaciones técnicas



Pag 40

### Modelo **MAR ET**

- Construida totalmente en Acero Inoxidable AISI-304.
- Unidad Condensadora Remota Totalmente protegida y conectada a la vitrina mediante tubo de 2.0 metros con carga de Gas R-290 incluida.
- Doble iluminación LED.
- Puertas abatibles en metacrilato hasta estante intermedio.

Doble  
iluminación  
**LED**

**MAR 150 ET INOX**

Parrillas  
**INCLUIDAS**



Pídanos Presupuesto

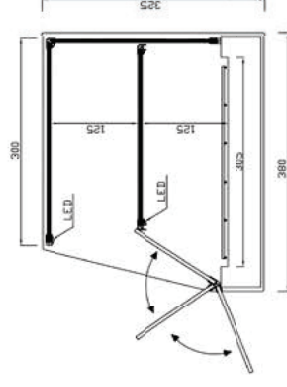
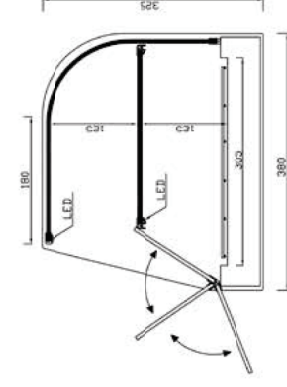
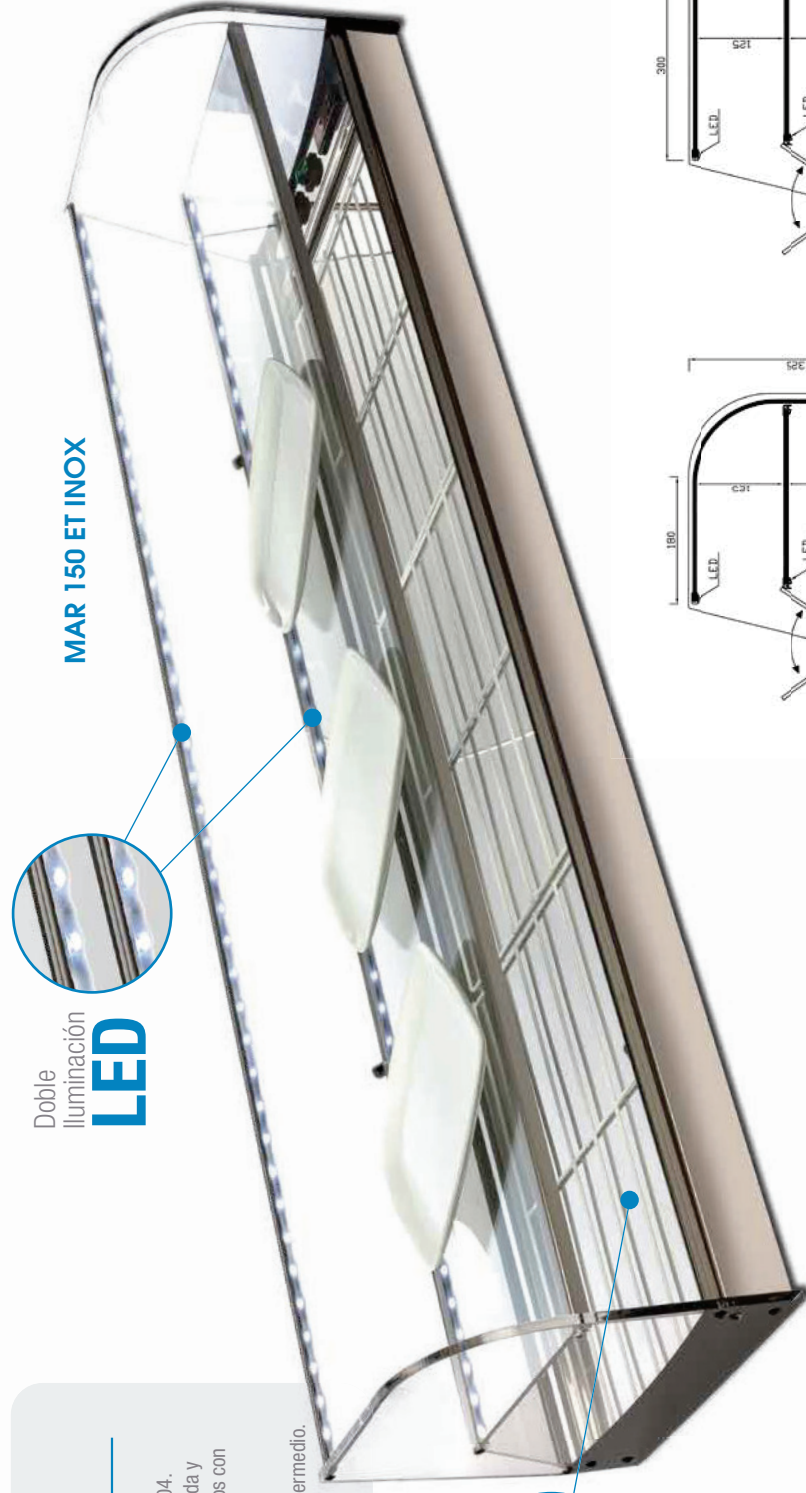

Colores disponibles:

Modelo	Largo	Fondo	Alto	Parrillas incluidas	PVP	
MAR-120 ET	MAR-120 ETR	1216	380	325	2	1.445 €
MAR-150 ET	MAR-150 ETR	1516	380	325	3	1.520 €
MAR-200 ET	MAR-200 ETR	2016	380	325	4	1.680 €
MAR-240 ET	MAR-240 ETR	2416	380	325	5	2.255 €
MAR-300 ET	MAR-300 ETR	3016	380	325	6	2.830 €



PLATA



NOGAL



BLANCO



NEGRO

ACERO  
INOXIDABLE



# GRUPO REMOTO

## VITRINA REFRIGERADA DE CUBETAS



Modelo  
**MAR F ET**

Estante intermedio

### SUPLEMENTO CUBETA

MELAMINA 1/3 h40

6 uds. 8 uds. 10 uds. 13 uds.

72 € 96 € 120 € 156 €

Doble  
iluminación  
**LED**

**MAR F8 ETR INOX**

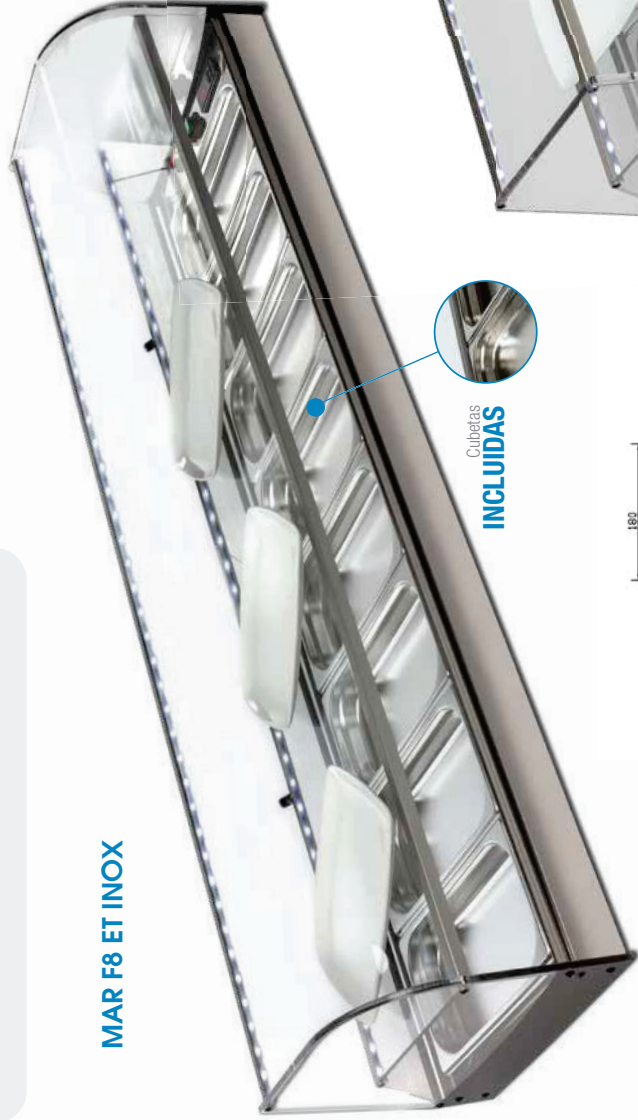
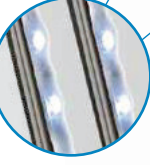

Cubetas  
**INCLUIDAS**

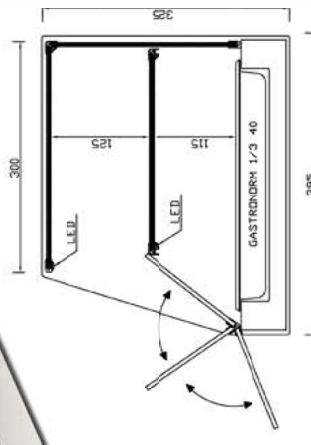
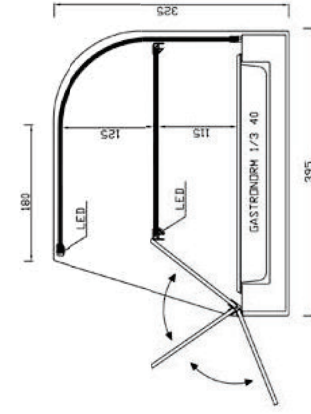

Pídanos Presupuesto

Colores disponibles:



Modelo	Largo	Fondo	Alto	Cubetas incluidas	PVP
MAR-F6 ET	1156	395	325	6	1.500 €
MAR-F8 ET	1516	395	325	8	1.560 €
MAR-F10 ET	1866	395	325	10	1.720 €
MAR-F13 ET	2416	395	325	13	2.290 €

PLATA

NOGAL

BLANCO

NEGRO

ACERO  
INOXIDABLE

Acero Inoxidable

### Modelo

## MFR

- Construida totalmente en Acero Inoxidable AISI-304 con marco decorativo.
- Cubetas Gastronorm 1/3 h40 o parrillas incluidas en la vitrina 450x280.
- Iluminación LED.
- Puertas correderas en metacrilato.
- Unidad condensadora remota totalmente protegida y conectada a la vitrina mediante tubo de 2,00 metros. Con carga de Gas R-290 incluida.

#### SUPLEMENTO CUBETA

MELAMINA 1/3 h40

6 uds. 8 uds. 10 uds. 14 uds.

72 € 96 € 120 € 168 €

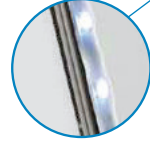

Iluminación  
**LED**

**MFR-6**



Cubetas  
**INCLUIDAS**

Modelo	Largo	Fondo	Alto	Cubetas (Incluidas)	PVP
MFR-6	1230	430	250	6	1.990 €
MFR-8	1590	430	250	8	2.115 €
MFR-10	1940	430	250	10	2.295 €
MFR-14	2640	430	250	14	3.120 €
Modelo	Largo	Fondo	Alto	Parrillas (Incluidas)	PVP
MFR-120	1200	430	250	2	1.990 €
MFR-150	1500	430	250	3	2.115 €
MFR-200	2000	430	250	4	2.345 €
MFR-250	2500	430	250	5	3.050 €

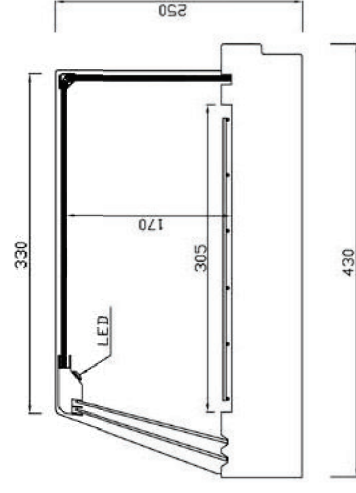
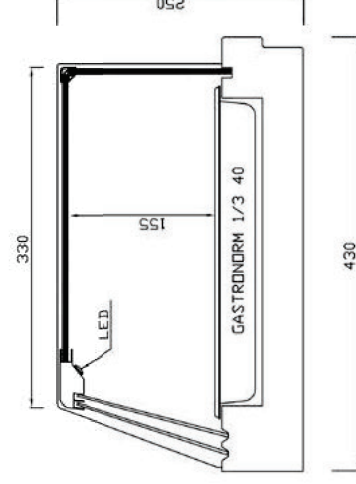



Modelo  
**MFR E**

Acero Inoxidable / Estante intermedio



Iluminación  
**LED**

**MFR-8E**



Cubetas  
**INCLUIDAS**

Fabricación Especial  
**A MEDIDA**  
Pídanos Presupuesto

Modelo	Largo	Fondo	Alto	Cubetas (Incluidas)	PVP
MFR-6E	1230	430	250	6	2.295 €
MFR-8E	1590	430	250	8	2.430 €
MFR-10E	1940	430	250	10	2.640 €
MFR-14E	2640	430	250	14	3.620 €

Modelo	Largo	Fondo	Alto	Parrillas (Incluidas)	PVP
MFR-120E	1200	430	250	2	2.295 €
MFR-150E	1500	430	250	3	2.430 €
MFR-200E	2000	430	250	4	2.640 €
MFR-250E	2500	430	250	5	3.500 €



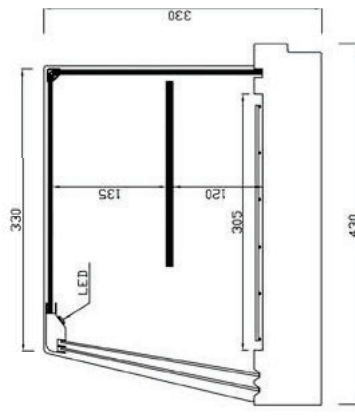
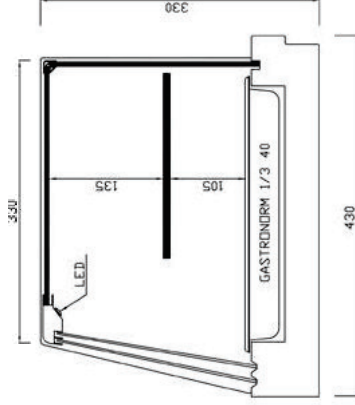

Acero inoxidable

Modelo  
**CST**

- Construida totalmente en Acero Inoxidable.
- La vitrina queda encastrada en la barra mediante un marco de acero inox. de 20 mm.
- Parrillas incluidas en la vitrina 450x280.
- Iluminación LED.
- Puertas Abatibles en metacrilato.
- Unidad condensadora remota totalmente protegida y conectada a la vitrina mediante tubo de 2.00 metros con carga de Gas R-290 incluida.

**CST 120**

Iluminación

**LED**

Vitrina encastrada en la barra mediante un marco de acero inox. de 20mm

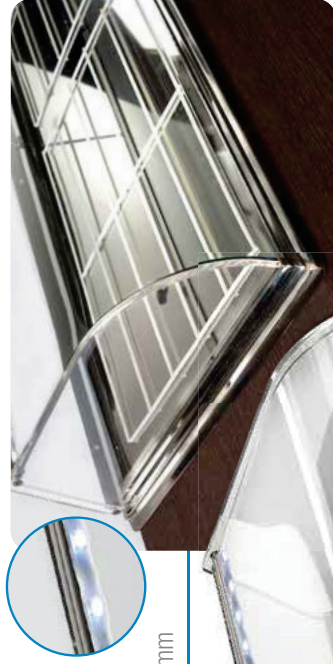

DETALLE PESTAÑA DE ENCASTRE

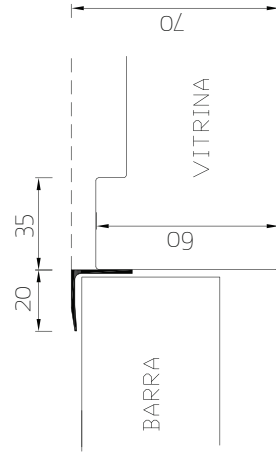
Parrillas  
**INCLUIDAS**Fabricación Especial  
**A MEDIDA**

Pídanos Presupuesto

Modelo	Largo	Fondo	Alto	Parrillas incluidas	PVP
CST-120	1220	380	130	2	1.710 €
CST-150	1520	380	130	3	1.785 €
CST-200	2020	380	130	4	1.965 €
CST-240	2420	380	130	5	2.660 €
CST-300	3020	380	130	6	3.330 €

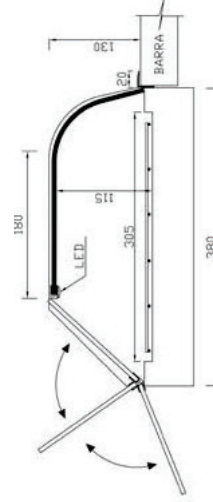
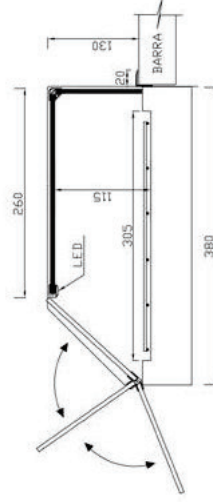

Modelo  
**CST F**

- Construida totalmente en Acero Inoxidable.
- La vitrina queda encastrada en la barra mediante un marco de acero inox. de 20 mm.
- Cubetas Gastronom 1/3 h40 incluidas según modelo.
- Iluminación LED.
- Puertas Abatibles en metacrilato.

**SUPLEMENTO CUBETA**  
MELAMINA 1/3 h40  
6 uds. 8 uds. 10 uds. 13 uds.  
72 € 96 € 120 € 156 €



Acero Inoxidable

**CST F6**



**CST F6R**



Iluminación  
**LED**



Cubetas  
**INCLUIDAS**



Cubetas  
**INCLUIDAS**

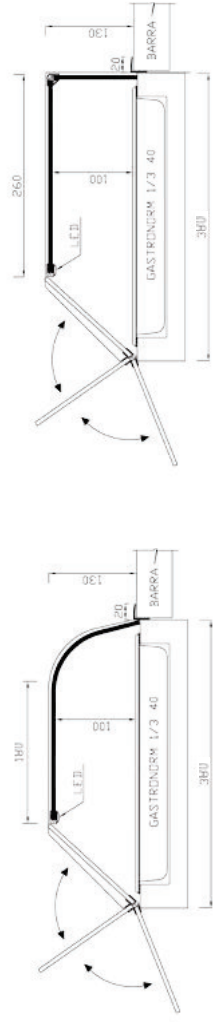

Modelo	Largo	Fondo	Alto	Cubetas incluidas	PVP
<b>CST-F6</b>	1170	380	130	6	1.755 €
<b>CST-F8</b>	1520	380	130	8	1.845 €
<b>CST-F10</b>	1870	380	130	10	2.020 €
<b>CST-F13</b>	2420	380	130	13	2.690 €



Acero inoxidable / Ideal para pinchos

## Modelo PCH

- Construida totalmente en Acero Inoxidable AISI-304.
- Unidad Condensadora Remota Totalmente protegida y conectada a la vitrina mediante tubo de 2.00 metros con carga de Gas R-290 incluida.
- Doble Iluminación LED.
- Puertas abatibles en metacrilato a ambos lados.
- Accesorios de vitrina no incluidos.

Doble Iluminación **LED**

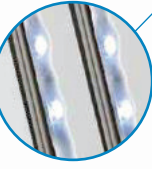

PCH 150



Pídanos Presupuesto

Parrillas **INCLUIDAS**



PUERTAS ABATIBLES

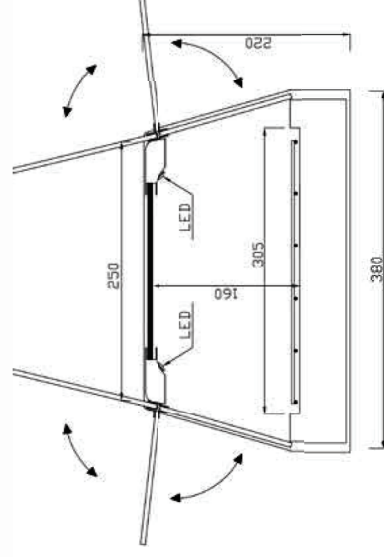

Modelo	Largo	Fondo	Alto	Parrillas incluidas	PVP
PCH-120	1216	380	220	2	1.385 €
PCH-150	1516	380	220	3	1.450 €
PCH-200	2016	380	220	4	1.595 €
PCH-250	2516	380	220	5	2.170 €
PCH-300	3016	380	220	6	2.700 €



Plata - Nogal - Blanco - Negro / Ideal para Pinchos

Modelo **VPI**

- Perfilera en Aluminio color PLATA - NOGAL - BLANCO - NEGRO.
- Parrillas incluidas en la vitrina 450x280.
- Accesorios de vitrina no incluidos.
- Unidad Condensadora Remota totalmente protegida y conectada a la vitrina mediante tubo de 2.0 metros con carga de Gas R-290 incluida.
- Doble iluminación LED.
- Puertas Correderas en Metacrilato a ambos lados.

**VPI-120 NEGRO**

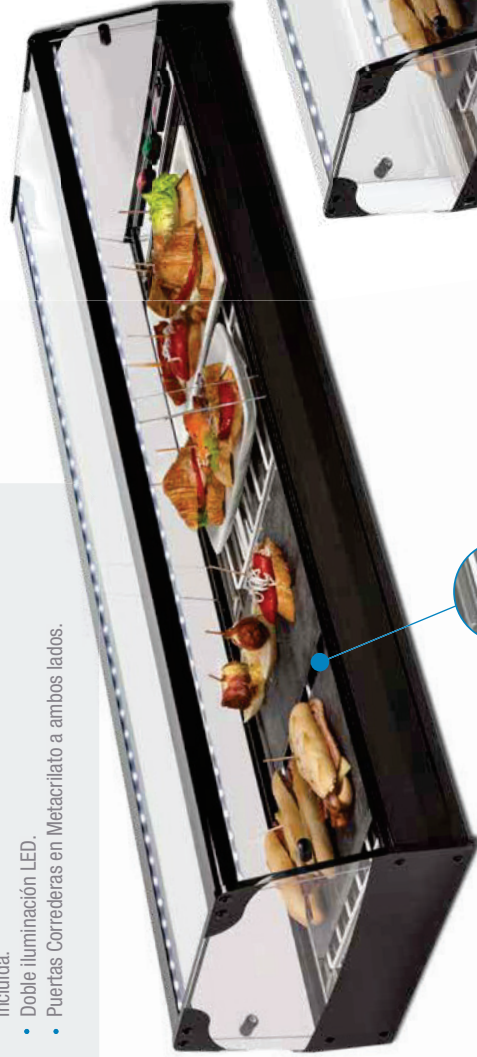

Parrillas **INCLUIDAS**



**VPI-150i BLANCO**

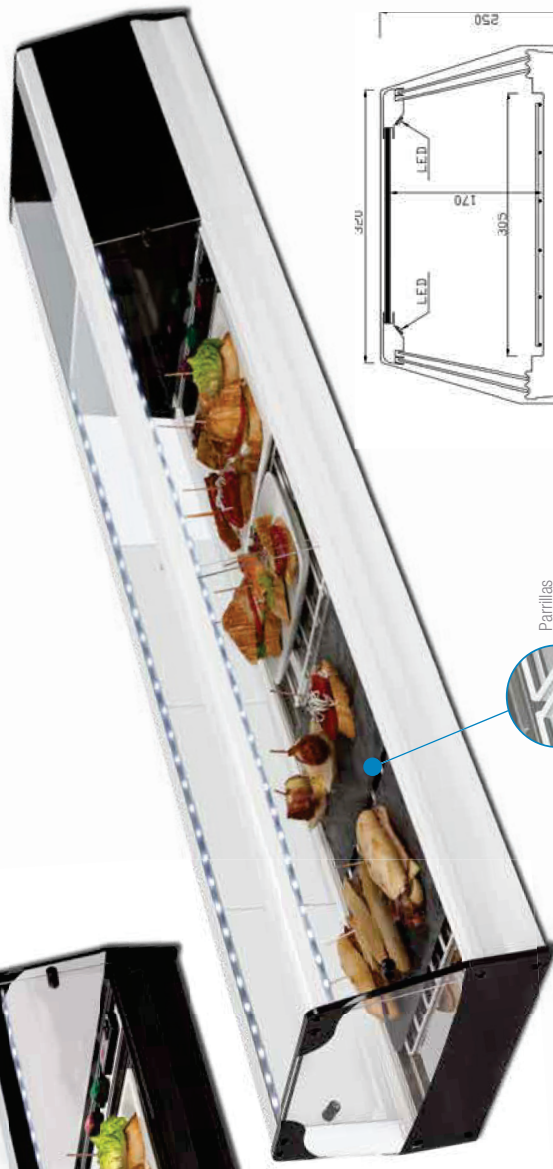

Parrillas **INCLUIDAS**



Doble Iluminación **LED**

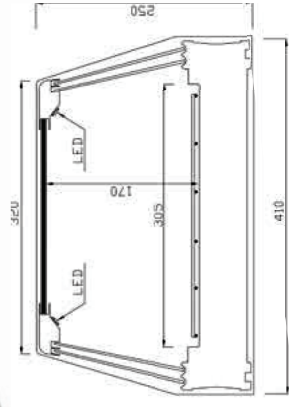

Modelo	Largo	Fondo	Alto	Modelo	Largo	Fondo	Alto	Parrillas incluidas	PVP
<b>VPI-120</b>	1216	410	250	<b>VPI-120i</b>	1216	410	250	2	1.190 €
<b>VPI-150</b>	1516	410	250	<b>VPI-150i</b>	1516	410	250	3	1.250 €
<b>VPI-200</b>	2016	410	250	<b>VPI-200i</b>	2016	410	250	4	1.380 €
<b>VPI-250</b>	2516	410	250	<b>VPI-250i</b>	2516	410	250	5	1.865 €

Frío en Placa Fría y Evaporador Superior

CRISTAL  
RECTOTemperatura  
de Trabajo

+1°/+5°

Accesorios  
disponiblesPag  
82Especif.  
técnicasPag  
40

Modelo

**SU-GR**

NOVEDAD

- FRÍO ESTÁTICO EN PLACA FRÍA Y EPAPORADOR SUPERIOR.
- Bandeja para desague de Evaporador Superior.
- Manguera de Desagüe en la zona de camarero.
- Decoración de cristal en NEGRO.
- Unidad condensadora Remota protegida y conectada a vitrina con carga de Gas R-290 incluida.
- Iluminación LED.
- Puertas correderas de metacrilato.

SU-6GR

PERFIL UNIÓN CRISTAL

EVAPORADOR SUPERIOR

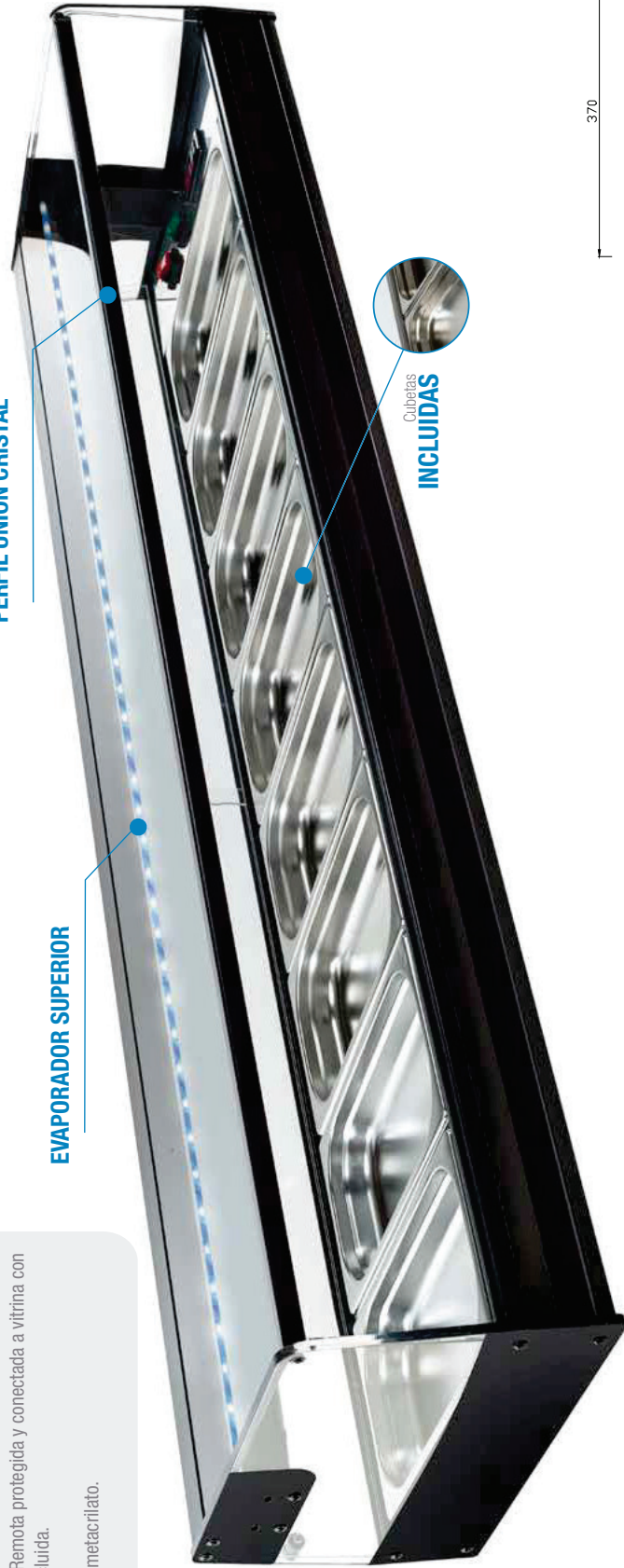
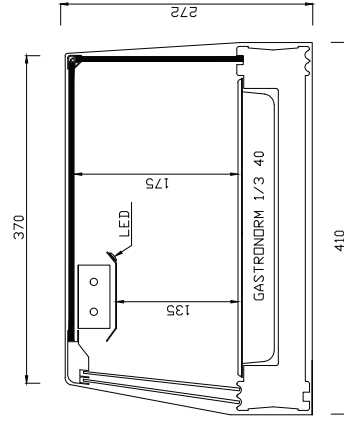
Cubetas  
INCLUIDAS

**SUPLEMENTO CUBETA**  
MELAMINA 1/3 h40  
6 uds. 8 uds. 10 uds.  
72 € 96 € 120 €

Modelo	Largo	Fondo	Alto	Cubetas	Plata/Nogal/Blanco/Negro
SU-6GR	1156	410	272	6	1.445 €
SU-8GR	1516	410	272	8	1.480 €
SU-10GR	1866	410	272	10	1.615 €

GRUPO REMOTO  
VITRINA REFRIGERADA SUSHI DE BANDEJA PLANA



PLATA



NOGAL

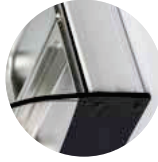

BLANCO



NEGRO



SU-150GR

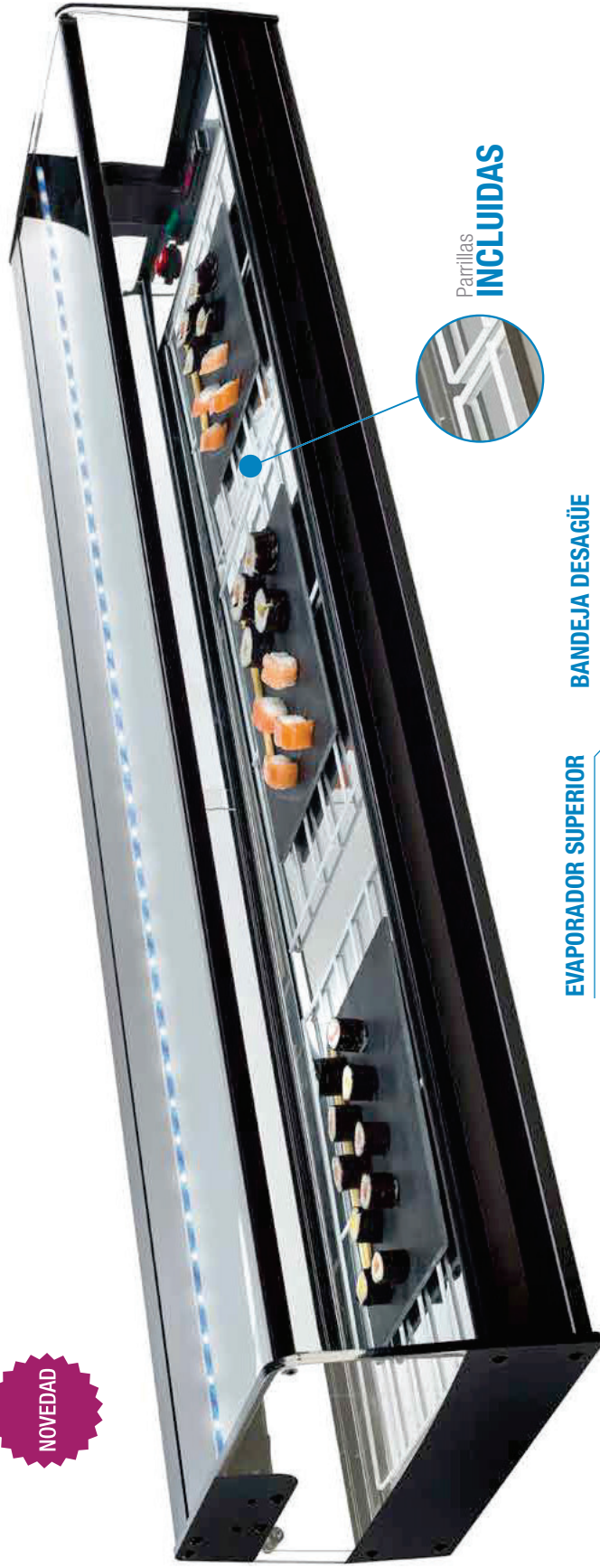

Parrillas  
**INCLUIDAS**



**EVAPORADOR SUPERIOR**

**BANDEJA DESAGÜE**

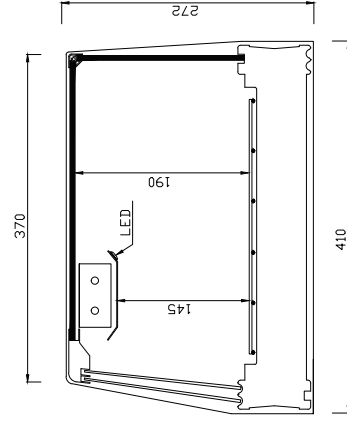

Modelo	Largo	Fondo	Alto	Parrillas	Plata/Nogal/Blanco/Negro
SU-120GR	1216	410	272	2	1.425 €
SU-150GR	1516	410	272	3	1.460 €
SU-200GR	1926	410	272	4	1.640 €



# GRUPO REMOTO

## VITRINA REFRIGERADA SUSHI

Frío en Placa Fría y Evaporador Superior

### Modelo SHS

- FRÍO ESTÁTICO EN PLACA FRÍA Y EPAPORADOR SUPERIOR.
- Bandeja para desague de Evaporador Superior.
- Manguera de Desagüe en la zona de camarero.
- Perfilera y decoración de cristal en NEGRO.
- Cristal Curvo Templado Radio 20°.
- Unidad condensadora Remota protegida y conectada a vitrina con carga de Gas r-290 incluida.
- Iluminación LED.
- Puertas correderas de metacrilato.



CRISTAL CURVADO RADIO 20°

### SHS-8GR

#### EVAPORADOR SUPERIOR



Cubetas  
**INCLUIDAS**

Iluminación  
**LED**

### SHS-150GR



Parrillas  
**INCLUIDAS**

### SUPLEMENTO CUBETA MELAMINA 1/3 h40

6 uds. 8 uds. 10 uds.  
72 € 96 € 120 €

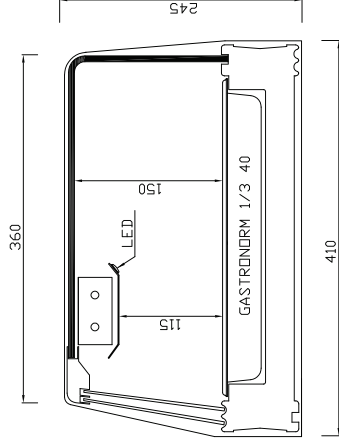

Modelo	Largo	Fondo	Alto	Cubetas	PVP
SHS-6GR	1216	410	245	6	1.690 €
SHS-8GR	1566	410	245	8	1.770 €
SHS-10GR	1926	410	245	10	1.960 €

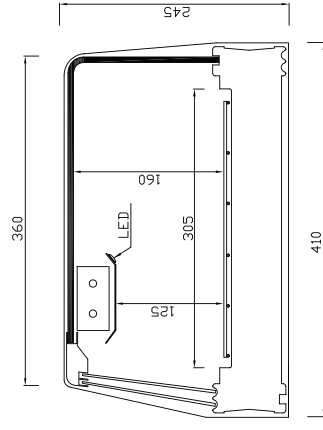

Modelo	Largo	Fondo	Alto	Parrillas	PVP
SHS-120GR	1216	410	245	2	1.670 €
SHS-150GR	1566	410	245	3	1.750 €
SHS-200GR	1926	410	245	4	1.940 €

SHS-6EGR



SHS-120EGR

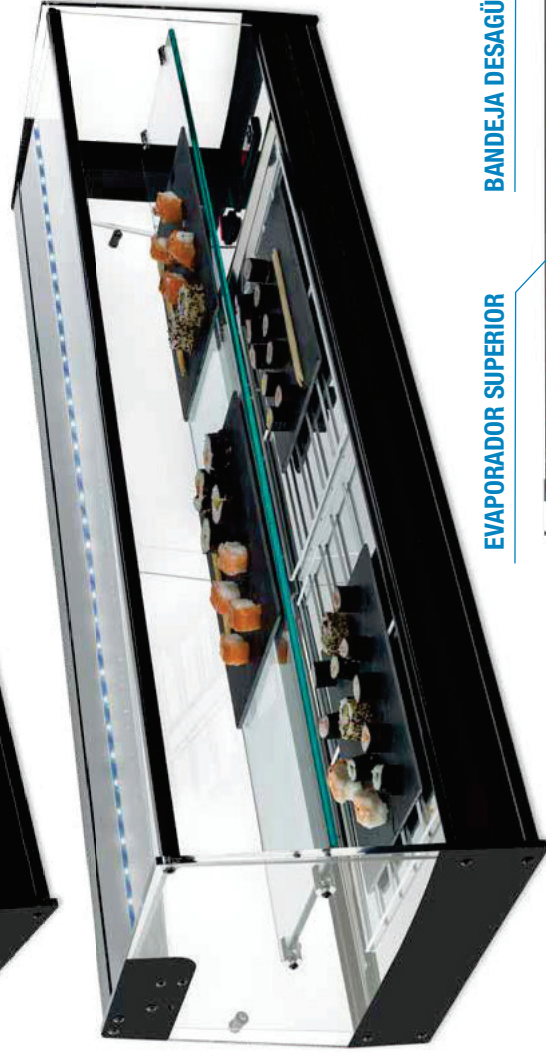

EVAPORADOR SUPERIOR

BANDEJA DESAGÜE



**SUPLEMENTO CUBETA**  
MELAMINA 1/3 h40  
6 uds. 8 uds. 10 uds.  
72 € 96 € 120 €

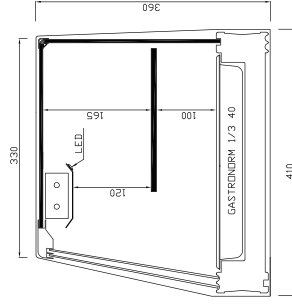

Modelo	Largo	Fondo	Alto	Cubetas	PVP
SHS-6EGR	1216	410	360	6	1.720 €
SHS-8EGR	1566	410	360	8	1.770 €
SHS-10EGR	1926	410	360	10	1.955 €

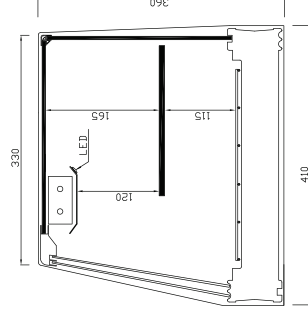

Modelo	Largo	Fondo	Alto	Parrillas	PVP
SHS-120EGR	1216	410	360	2	1.700 €
SHS-150EGR	1566	410	360	3	1.750 €
SHS-200EGR	1926	410	360	4	1.935 €

CRISTAL  
RECTOTemperatura  
de Trabajo

+1°/+5°

Accesorios  
disponiblesPag  
82Especificaciones  
técnicasPag  
40Doble  
iluminación

LED

TR-3 150 MAX ACERO INOXIDABLE  
Tres alturasModelo  
TR 3

- Construida totalmente en Acero Inoxidable AISI-304.
- Parrillas incluidas en la vitrina 450x280
- Unidad Condensadora Remota Totalmente protegida y conectada a la vitrina mediante tubo de 2.00 metros con carga de Gas R-290 incluida.
- Iluminación LED en cada estante.
- Puertas abatibles en metacrilato hasta primer estante. Perfilera en aluminio color PLATA – NOGAL – BLANCO – NEGRO o ACERO INOXIDABLE.

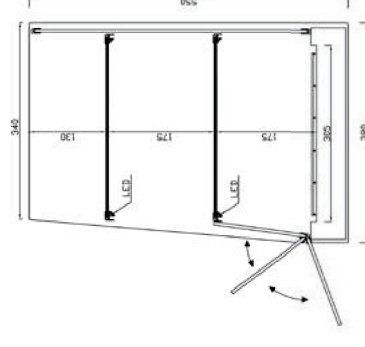
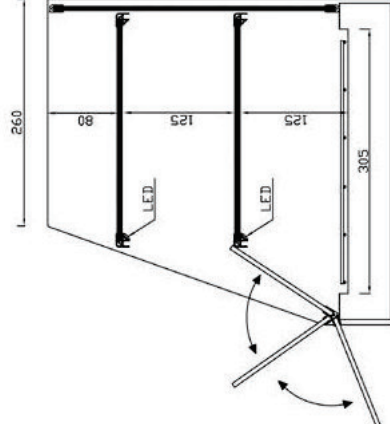
Parrillas  
INCLUIDAS

Modelo	Largo	Fondo	Alto	Parrillas incluidas	PVP
TR-3 120	1216	380	400	2	1.585 €
TR-3 150	1516	380	400	3	1.660 €
TR-3 200	2016	380	400	4	1.835 €
TR-3 250	2516	380	400	5	2.450 €
TR-3 300	3016	380	400	6	3.090 €

Modelo	Largo	Fondo	Alto	Parrillas incluidas	PVP
TR-3 120 MAX	1216	380	550	2	1.700 €
TR-3 150 MAX	1516	380	550	3	1.770 €
TR-3 200 MAX	2016	380	550	4	1.945 €
TR-3 250 MAX	2516	380	550	5	2.570 €
TR-3 300 MAX	3016	380	550	6	3.200 €



Colores disponibles:



PLATA



NOGAL



BLANCO



NEGRO

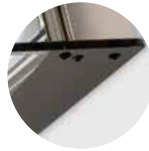

ACERO  
INOXIDABLE

GRUPO REMOTO

VITRINA REFRIGERADA

Tres alturas - totalmente cerradas



## Modelo FR-ER2

- Cubetas gastronorm 1/3 h40 o parrillas 450x280 incluidas en la vitrina.
- Unidad Condensadora Remota totalmente protegida y conectada a la vitrina mediante tubo de 2.00 metros con carga de Gas R-290 incluida.
- Iluminación LED en cada estante.
- Puertas Correderas en metacrilato.

NOVEDAD

## FR-120 ER2 NEGRO

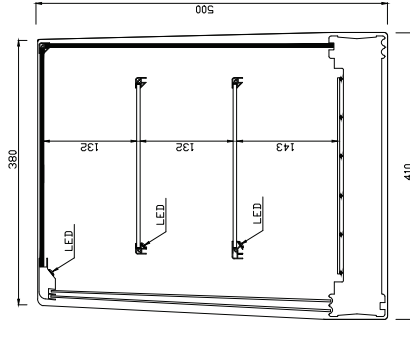
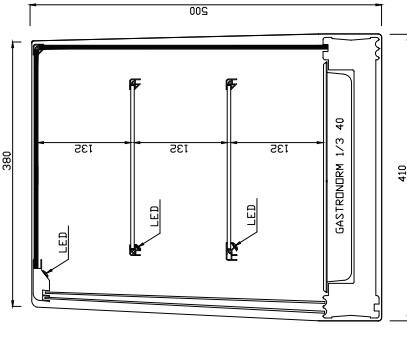
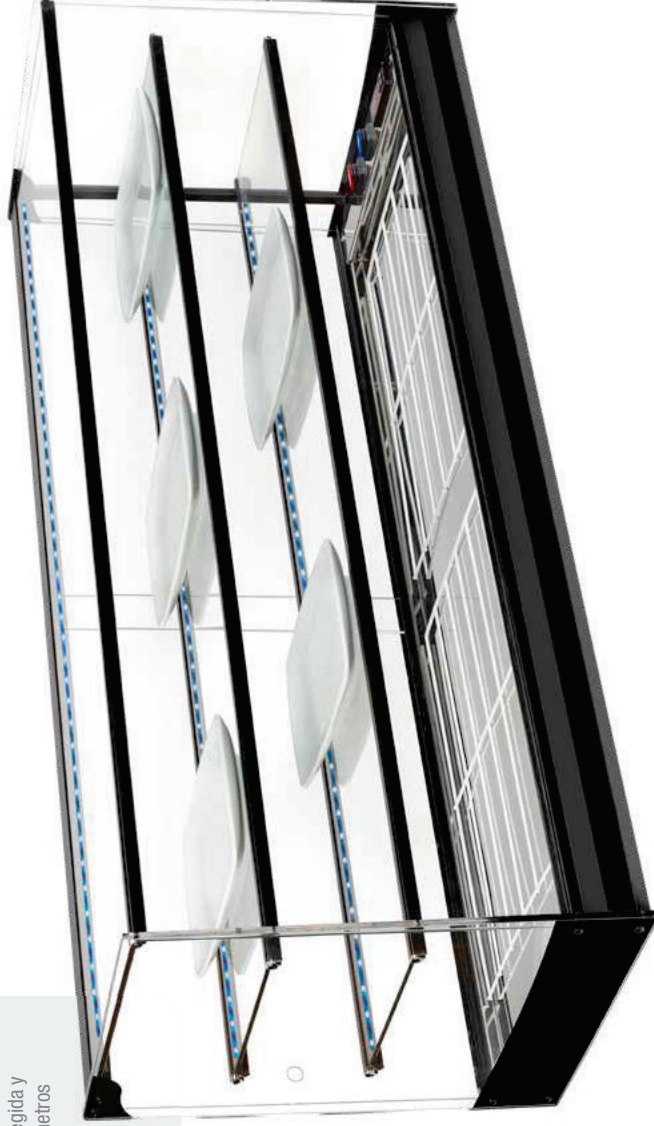

Fabricación Especial  
**A MEDIDA**

Pídanos Presupuesto

Modelo	Largo	Fondo	Alto	Parrillas (Incluidas)	PVP
FR-120ER2	1216	410	500	2	1.710 €
FR-150ER2	1516	410	500	3	1.950 €
FR-200ER2	2016	410	500	4	2.300 €

Modelo	Largo	Fondo	Alto	Cubetas (Incluidas)	PVP
FR-4ER2	806	410	500	4	1.655 €
FR-6ER2	1156	410	500	6	1.760 €
FR-8ER2	1516	410	500	8	1.970 €
FR-10ER2	1866	410	500	10	2.290 €

Dos Vitrinas en una

CRISTAL  
RECTOTemperatura  
de TrabajoFrio +1º/ 5ºC  
Calor +20º/ 90ºC

Modelo

**MIX-2****Características Zona Fría**

- Zona inferior refrigerada de cubetas.
- Puertas correderas en metacrilato de 3mm guiadas sobre perfil curvo SANITARIO para una fácil limpieza.
- Laterales en metacrilato.
- Control de temperatura mediante termostato digital.
- Doble iluminación LED.

**Características Zona Caliente**

- Zona de vitrina calor seco de cubetas.
- Sistema de calor mediante cable calefactor de 30W/m. adosado a la base de la vitrina por la parte inferior.
- Aislamiento térmico de la vitrina con lana de roca Euro
- Clase A1.
- Iluminación LED.
- Esta vitrina no viene preparada para utilizarla al baño maría.

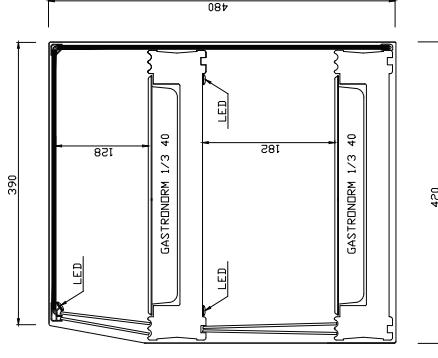
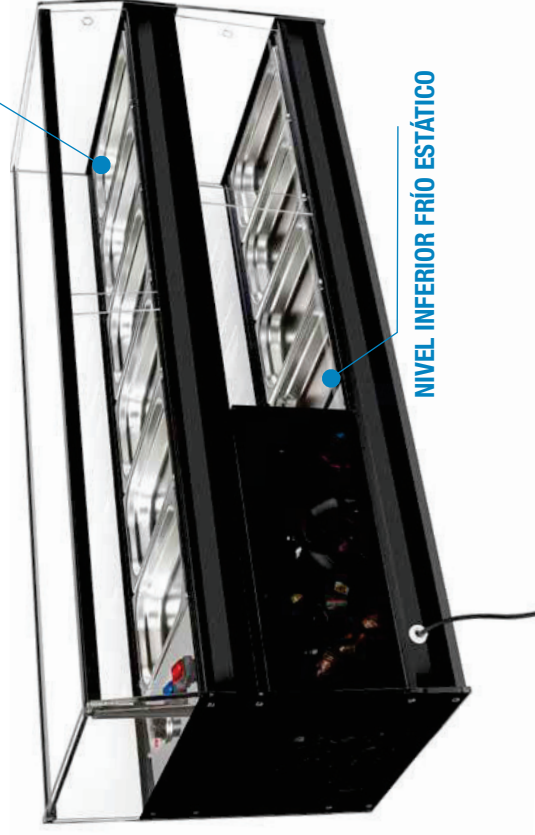
**MIX-2F4****NIVEL SUPERIOR CALOR SECO****NIVEL INFERIOR FRÍO ESTÁTICO**Fabricación Especial  
**A MEDIDA**  
Pídanos Presupuesto**SUPLEMENTO CUBETA**  
MELAMINA 1/3 h.40  
6 uds. - 8 uds. - 10 uds.  
72 € - 96 € - 120 €

Modelo	Largo	Fondo	Alto	Cubetas inferior	Cubetas superior	PVP
<b>MIX-2F4</b>	1156	420	480	4	6	2.120 €
<b>MIX-2F6</b>	1516	420	480	6	8	2.345 €
<b>MIX-2F8</b>	1866	420	480	8	10	2.690 €

Modelo **DBF**

- Vitrina refrigerada de doble altura (FRÍO EN LAS DOS ALTURAS).
- ZONA INFERIOR : Cubetas Gastronorm 1/3 h40.
- ZONA SUPERIOR: Placa fría con parrillas incluidas.
- Platos no incluidos.
- Unidad Condensadora Remota Totalmente protegida y conectada a la vitrina mediante tubo de 2.00 metros con carga de Gas R-290 incluida.
- Triple Iluminación LED.
- Puertas Correderas.
- Perfilera en color Plata

DB-F6

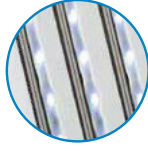

Triple Iluminación LED



Cubetas INCLUIDAS



SUPLEMENTO CUBETA MELAMINA 1/3 h40  
6 uds. 8 uds. 10 uds.  
72 € 96 € 120 €

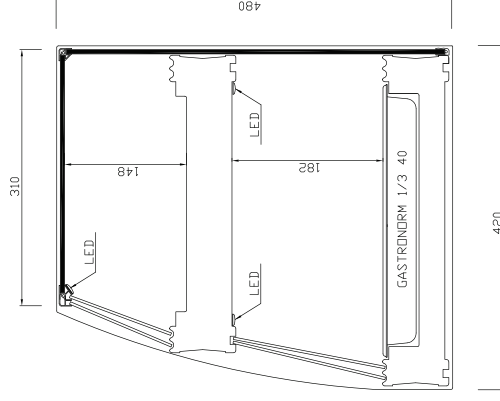

Fabricación Especial **A MEDIDA**  
Pídanos Presupuesto

Modelo	Largo	Fondo	Alto	Cubetas (Incluidas)	Parrillas (Incluidas)	PVP
DB-F6	1156	420	480	6	2	2.020 €
DB-F8	1516	420	480	8	3	2.235 €
DB-F10	1866	420	480	10	4	2.565 €





Temperatura de Trabajo

+1°/+5°



Accesorios disponibles

Pag 82



Especificaciones técnicas

Pag 40

Modelo  
**PF**

- FRÍO ESTÁTICO EN PLACA FRÍA.
- Fabricada en Acero Inoxidable AIS-304.
- Cristal templado desmontable opcional.
- Totalmente abierta para la exposición de pescados, mariscos, tapas, sushi, etc.
- Unidad condensadora Remota protegida y conectada a la vitrina mediante tubo de 2.00 metros con carga de Gas R-290 incluida.
- POSIBILIDAD DE FABRICARLA EN CUALQUIER MEDIDA BAJO PRESUPUESTO.

**CRISTAL DESMONTABLE OPCIONAL**

PF-120



Pídanos Presupuesto

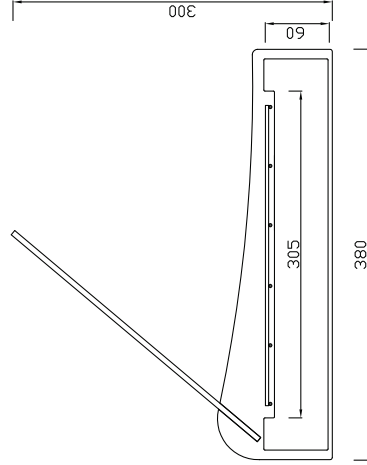

Modelo Largo Fondo Alto Parrillas PVP Cristal PVP

<b>PF-120</b>	1216	380	300	2	1.060 €	130 €
<b>PF-150</b>	1566	380	300	3	1.120 €	160 €
<b>PF-200</b>	2016	380	300	4	1.235 €	190 €

Temperatura de Trabajo +1°/+5°



Accesorios disponibles Pag 82

Especificaciones técnicas Pag 40

GRUPO REMOTO

PLACA FRÍA PARA ENCASTRAR EN BARRA

Acero Inoxidable



## Modelo PFCST

- FRÍO ESTÁTICO EN PLACA FRÍA.
- Fabricada en acero inoxidable AIS-304.
- La vitrina queda encastrada en la barra mediante un marco de acero inox. de 20 mm.
- Cristal templado desmontable opcional.
- Totalmente abierta para la exposición de pescados, mariscos, tapas, sushi, etc.
- Unidad condensadora Remota protegida y conectada a la vitrina mediante tubo de 2.00 metros con carga de Gas R-290 incluida.
- POSIBILIDAD DE FABRICARLA EN CUALQUIER MEDIDA BAJO PRESUPUESTO.

PFCST-150

CRISTAL DESMONTABLE OPCIONAL

Fabricación Especial  
**A MEDIDA**

Pídanos Presupuesto

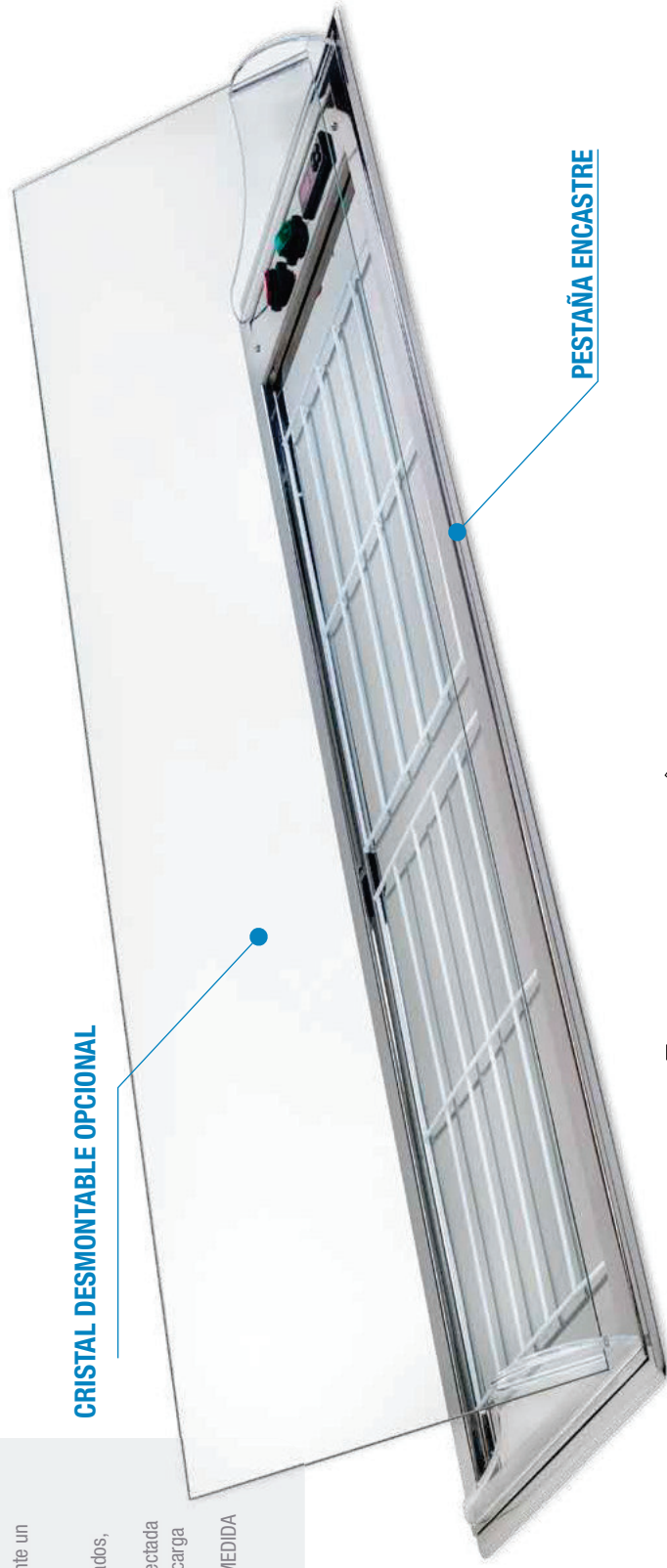

PESTAÑA ENCASTRE

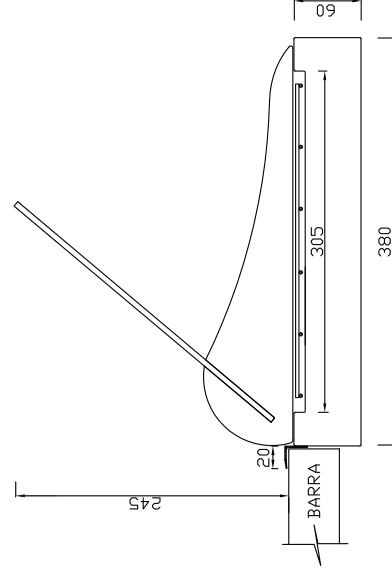

DETALLE PESTAÑA DE ENCASTRE

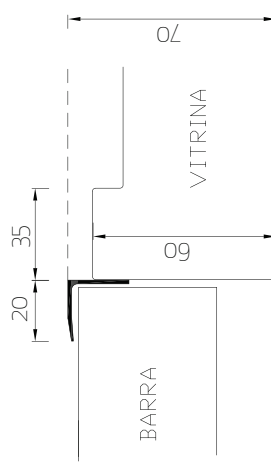

Modelo	Largo	Fondo	Alto	Parrillas	PVP	Cristal PVP
PFCST-120	1220	380	245	2	1.590 €	130 €
PFCST-150	1520	380	245	3	1.650 €	160 €
PFCST-200	2020	380	245	4	1.815 €	190 €

# VITRINAS MIXTAS/GRUPO REMOTO VITRINA REFRIGERADA + VITRINA CALOR

Dos Vitrinas en una

## Modelo MIX 200

### Características Zona Fría 1200 mm.

- Zona de vitrina frigorífica de bandeja plana ideal para la exposición de mariscos, pescados, pinchos, sushi, etc.
- Unidad condensadora totalmente protegida con chapa en acero galvanizado y conectada a la vitrina mediante tubo protegido de 1800 mm. de largo.
- Cristal curvo fijo 5 mm.
- Puertas de corredera en metacrilato de 3 mm guiadas sobre perfil curvo SANITARIO para una fácil limpieza.
- Laterales en metacrilato.
- Control de temperatura mediante termostato digital.
- Iluminación LED.

### Características Zona Caliente 800 mm.

- Zona de vitrina caliente de bandeja plana ideal para la exposición de pizza, bocadillos, bollería, tapas, etc.
- Sistema de calor mediante cable calefactor de potencia constante con un consumo de 30W/m. adosado a la base de la vitrina por la parte inferior.
- Aislamiento térmico de la vitrina con lana de roca Euro Clase A1.
- Iluminación LED.
- Esta vitrina no viene preparada para utilizarla al baño maría.

### POSIBILIDAD DE CONSTRUIR DIVERSAS MODALIDADES

Bajo Presupuesto

- Zona Fría + Zona Caliente
- Zona Fría + Zona Neutra
- Zona Caliente + Zona Neutra
- Zona Fría + Zona Caliente + Zona Neutra



Iluminación  
**LED**

### MIX-200 PLATA

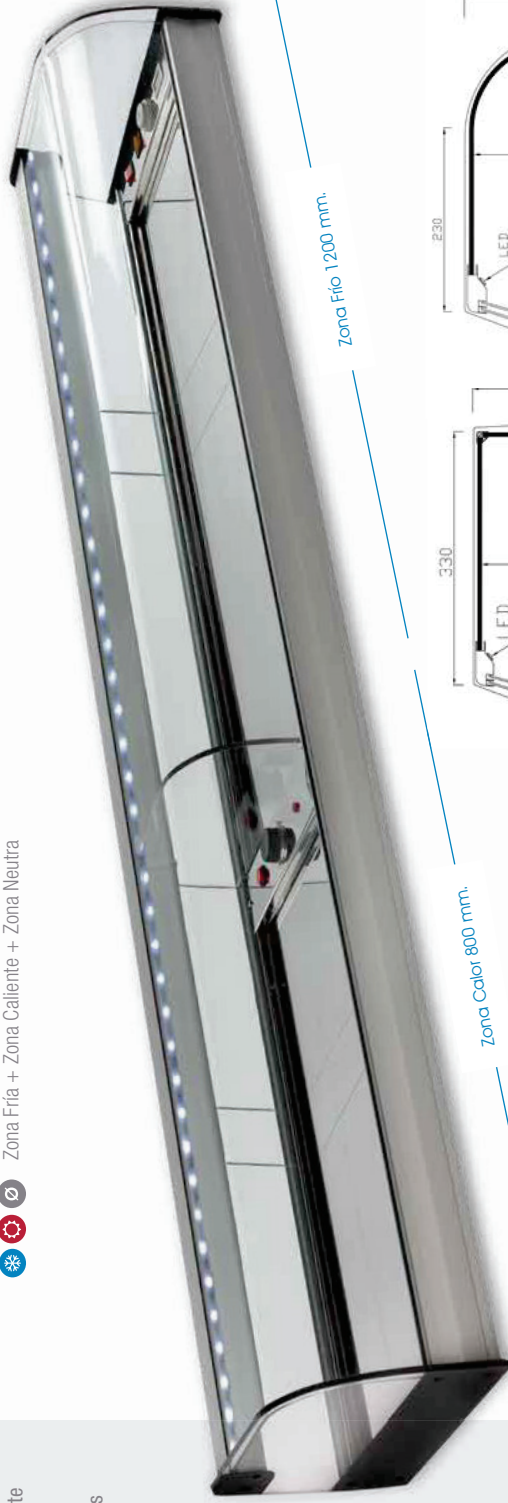

Zona Frío 1200 mm.

Zona Calor 800 mm.

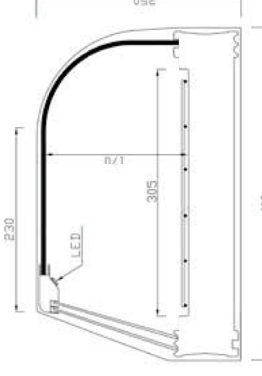
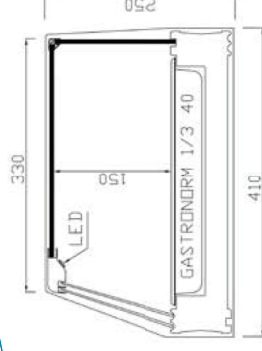

Pídanos Presupuesto

Colores disponibles



PLATA



NOGAL



BLANCO



NEGRO

Modelo	Largo	Fondo	Alto	Zona Fría	PVP
MIX-200	2016	410	250	R-290	1.760 €
MIX-200R	2016	410	250	R-290	1.760 €

Potencia  
(Zona Caliente)

363 W / 230 V  
363 W / 230 V





Temperatura de Trabajo



+1°/+5°



Especificaciones técnicas

Pag 40

GRUPO REMOTO

VITRINA REFRIGERADA PARA INGREDIENTES

Estante Intermedio



Modelo

**PZ 1/4**

- Fabricada en Acero Inoxidable AIS-304.
- FRÍO ESTÁTICO EN LA ZONA INFERIOR Y LATERALES DE VITRINA.
- Opción de cerraría con Cristal Recto.
- ILUMINACIÓN LED.
- Cubetas GN 1/4 H150 con tapas en policarbonato (incluidas)
- Tapa de motor en Polietileno 15 mm.

POLIETILENO

**PZ6 1/4**

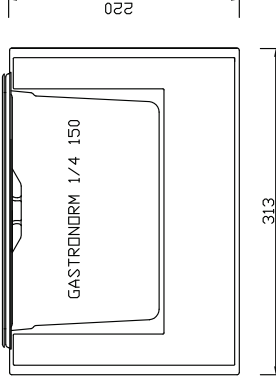

Iluminación

**LED**

Modelo	Largo	Fondo	Alto	CUBETAS GN 1/4 H150	PVP
<b>PZ6 1/4</b>	1496	313	220	6	1.450 €
<b>PZ8 1/4</b>	1826	313	220	8	1.620 €
<b>PZ10 1/4</b>	2156	313	220	10	1.890 €



TAPA CUBETA  
POLICARBONATO INCLUIDA

Modelo	Largo	Fondo	Alto	CUBETAS GN 1/4 H150	PVP
<b>PZ6 1/4CR</b>	1496	313	480	6	1.675 €
<b>PZ8 1/4CR</b>	1826	313	480	8	1.855 €
<b>PZ10 1/4CR</b>	2156	313	480	10	2.160 €

**PZ6 1/4 CR**

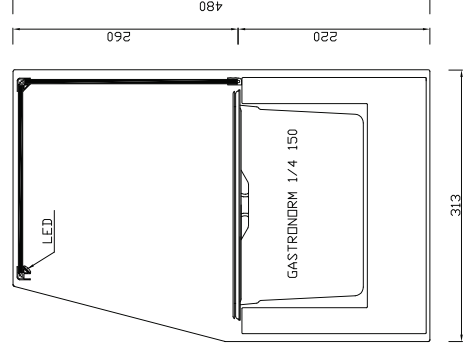
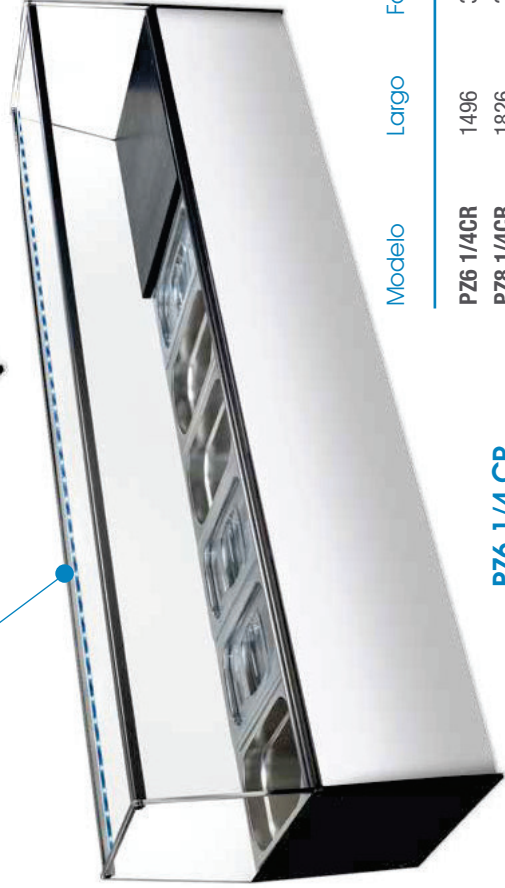

## Modelo ING 1/4

- Fabricada en Acero Inoxidable AISI-304.
- FRIO ESTÁTICO EN LA ZONA INFERIOR Y LATERALES DE VITRINA.
- Unidad condensadora Remota protegida y conectada a la vitrina mediante tubo de 1,80 metros.
- Con carga de Gas R-134<sup>o</sup> incluida.
- Opción de cerrarla con Cristal Recto.
- ILUMINACIÓN LED.
- Cubetas GN 1/4 h150 con tapas en policarbonato (incluidas)

### ING 6 1/4



Iluminación  
**LED**

### ING 6 1/4 CR

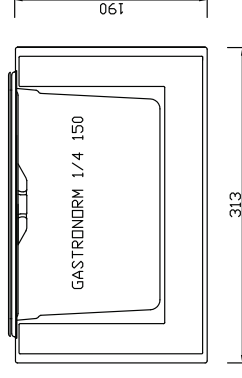

Modelo	Largo	Fondo	Alto	CUBETAS GN 1/4 H150	PVP
ING 6 1/4	1086	313	190	6	1.430 €
ING 8 1/4	1416	313	190	8	1.615 €
ING 10 1/4	1746	313	190	10	1.860 €

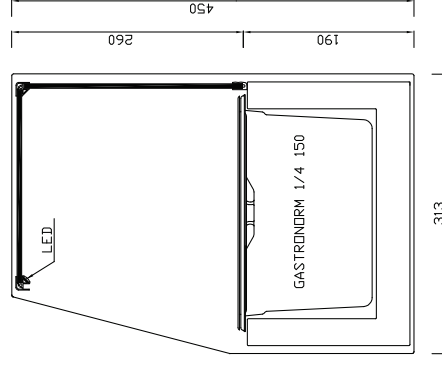

TAPA CUBETA  
POLICARBONATO INCLUIDA

Modelo	Largo	Fondo	Alto	CUBETAS GN 1/4 H150	PVP
ING 6 1/4 CR	1086	313	450	6	1.650 €
ING 8 1/4 CR	1416	313	450	8	1.820 €
ING 10 1/4 CR	1746	313	450	10	2.140 €

Temperatura de Trabajo



+1°/+5°

Especificaciones técnicas



Pag 40

GRUPO REMOTO

VITRINA REFRIGERADA PARA INGREDIENTES



Acero inoxidable

CUBETA GN 1/6 h150 y TAPA INCLUIDA

ING 7 1/6

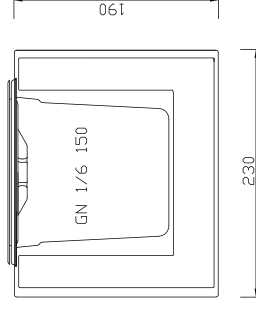

Modelo	Largo	Fondo	Alto	CUBETAS	PVP
ING 6 1/6	1086	230	190	6	1.145 €
ING 7 1/6	1250	230	190	7	1.190 €
ING 8 1/6	1416	230	190	8	1.245 €
ING 9 1/6	1580	230	190	9	1.295 €
ING 10 1/6	1746	230	190	10	1.320 €

Iluminación LED

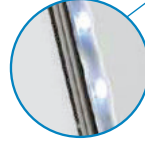

ING 7 1/6 CR

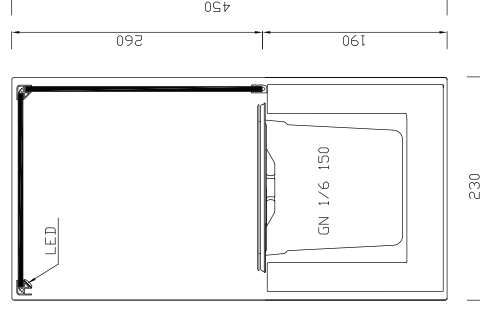

TAPA CUBETA POLICARBONATO INCLUIDA

Modelo	Largo	Fondo	Alto	CUBETAS	PVP
ING 6 1/6 CR	1086	230	450	6	1.310 €
ING 7 1/6 CR	1250	230	450	7	1.370 €
ING 8 1/6 CR	1416	230	450	8	1.435 €
ING 9 1/6 CR	1580	230	450	9	1.485 €
ING 10 1/6 CR	1746	230	450	10	1.520 €





### Modelo **FCL**

- Fabricada en Acero Inoxidable AISI-304.
- FRÍO ESTÁTICO EN LA ZONA INFERIOR Y LATERALES DE VITRINA.
- Unidad condensadora Remota protegida y conectada a la vitrina mediante tubo de 2.00 metros.
- Con carga de Gas R-134º incluida.
- Iluminación LED.
- Puertas correderas metacrilato.
- Cubetas GN 1/1 GN 1/4 GN 1/3 h100

### FCL-11-3



### CUBETAS GN 1/1 h100

530 x 325 x 100 cm

Modelo	Largo	Fondo	Alto	Cubetas	PVP
FCL 11-3	1080	595	450	3	1.525 €
FCL 11-4	1405	595	450	4	1.685 €
FCL 11-5	1730	595	450	5	1.960 €

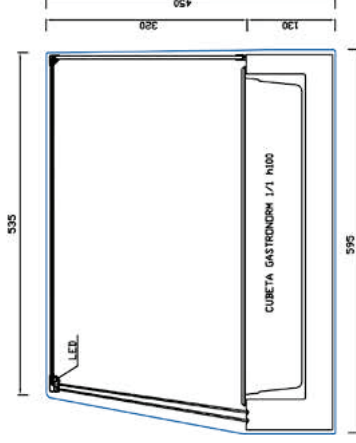

### CUBETAS GN 1/4 h100

162 x 265 x 100 cm





FCL-13-6

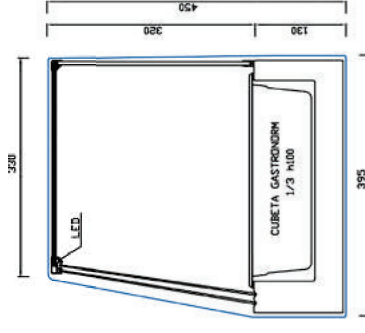

CUBETAS GN 1/3 h100

325 x175 x100 cm

Modelo	Largo	Fondo	Alto	Cubetas	PVP
FCL 13-6	1156	395	450	6	1.360 €
FCL 13-7	1331	395	450	7	1.490 €
FCL 13-8	1516	395	450	8	1.710 €

FCL-14-6

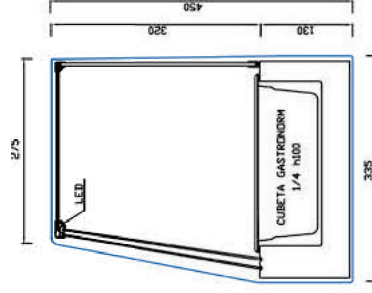

Modelo	Largo	Fondo	Alto	Cubetas	PVP
FCL 14-6	1078	335	450	6	1.190 €
FCL 14-8	1400	335	450	8	1.320 €
FCL 14-10	1726	335	450	10	1.540 €

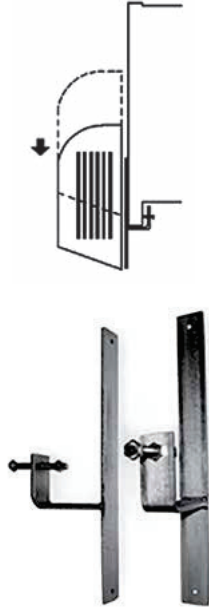

### SOPORTES DE VITRINA PARA BARRA

- Soporte de acero lacado para desplazar la vitrina del mostrador ganando espacio para el cliente.
- Se sirve en paquete de 2 unidades.

**P.V.P : 50,00€**



### BANDEJA MELAMINA GN 1/2

- Color Blanco / Negro.  
325 x 265 x 20 mm.

**P.V.P : 18,00€**



### CUBETA GASTRONORM 1/3 h40

- Acero inoxidable 18/10.  
325 x 175 x 40 mm.

**P.V.P : 11,00€**



### CUBETA MELAMINA BLANCA 1/3 h40

- Color Blanco  
325 x 175 x 40 mm.

**P.V.P : 22,00€**





### PLACA PIZARRA

- 300 x 200 x 5 mm.

**P.V.P : 12,00€**

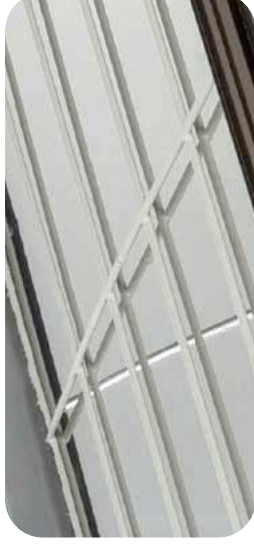

### PARRILLAS PLASTIFICADAS

- Color: Blanco.  
450 x 280 x 5 mm.

**P.V.P : 16,00€**



### BANDEJA PORCELANA

- 265 x 180 x 25 mm.

**P.V.P : 17,00€**